



SHANI INDUSTRIES.

Manufacturers & Exporters of Surgical, Dental, Orthodontic,
Hollow Wears & Manicure Instruments.

DENTAL Instruments Catalogue





Sheikh Zeeshan Shahid
(Managing Partner)



Sheikh Shahid Anwar (CEO)



Sheikh Usman Shahid
(Managing Partner)

The health of industry is one of the most important industries of every country, With the number of people getting admitted into hospitals, the equipment used needs to be top notch as well. Surgical instruments are the tools, which are used by doctors in hospitals while performing surgeries, operations and other kind of procedures. These are instruments designed in a different way in order to carry out specific actions. **Shani Industries** is playing a wide role in the surgical industry.

Shani Industries venture to come up to our customer satisfaction through quality, efficiency, Fast delivery on competitive prices, we would definitely want to help and share this business growth with our customer which can pave away towards better understanding and long term business relations.

HISTORY:

We are working in the field of Dental and Surgical instruments since the last 3 decades **Shani Industries** has been developing and producing general and customized instruments as per demand of our valuable customers including doctors, suppliers & distributors. We are 3rd generation in business of manufacturing started by its founder who has the vision of applying his experience in transforming metal into instruments with advanced medical tools technology.

Currently, We have export designer & Fabrications who are designing large variety of surgical instruments that are designed for purposes used by medical professional who are trained to use them.

Company:

Shani Industries is a leading global instruments manufacturing company that manufacture and export General Surgery, Dental & Beauty Instruments as well as Veterinary instruments used in a variety of complex medical procedures. We have been established for over 30 year global reputation for quality, excellence and outstanding services. The company is dedicated to enlighten all of its promoters, partners, honorable clients, distributors and medical professionals about the facility it is capable to provide.

Shani Industries has its production unit at Sialkot (Pakistan), from where it supplies its instruments to all over the world as well as looks after the progress of its sole representatives in selected regions of the world, gradually growing its business around the globe.

OUR PRODUCTS:

- Medical Instruments
- General Surgery Instruments
- Dental Instruments
- Veterinary Instruments
- Beauty Instruments
- Hollow Ware
- Single-Use Instruments
- Plastic Surgery Instruments
- Hair Transplant Instruments
- All Kinds of Scissors and Forceps

QUALITY POLICY:

Quality: We manufacture the instruments and packing exactly according to the customer demand.

Function: Our products always perfect for the function they are made for.

Feature: We carry out all the necessary tests, inspections and process control activities to ensure that there is no problem with the products. We will also give the technical specifications to improve the confidence of the customers.

Reliability: We give our customers the guarantee that our products are reliable in use even after using it up till extended period of time. Our products will perform their function efficiently more than any other product of similar nature in the market. All the products are made in our own facility by the workers who are best in their workmanship and commitment.

ACHIEVEMENTS:

Shani Industries have successfully achieved the approval of **cGMP, CE Mark, ISO 9001:2015, FDA** and European Medical Device Directive # **93/42 EEC** for **CE** Marking which manifestly reflects in the workmanship and standard of our products.

Kashmir Road, Sialkot, Pakistan

Mobile Contact  :+92 333 8628101 +92 322 7346631

Tel Office: +92 52 4265646

E-mail: info@shaniindustries.com URL: www.shaniindustries.com



01

EXTRACTING FORCEPS

Page # 01 - 28

02

ROOT ELEVATORS

Page # 29 - 48

03

**DIAGNOSTIC, PROBES, SCALERS, FILLING
& LABORATORY INSTRUMENTS**

Page # 49 - 98

04

**MAXILLOFACIAL SURGERY
INSTRUMENTS**

Page # 99 - 124

05

**ORTHODONTIC INSTRUMENTS
& PLIERS**

Page # 125 - 144

06

**DENTAL IMPLANT INSTRUMENTS
& Impression Tray**

Page # 145 - 182

07

HOLLOWWARE

Page # 183 - 191

Handle Selection For Extracting Forceps

Dear Valued Buyers if any Universal Fig. No. of Extracting Forceps not Found in our Catalogue you Can Refer the Fig. No. From These Diagram.

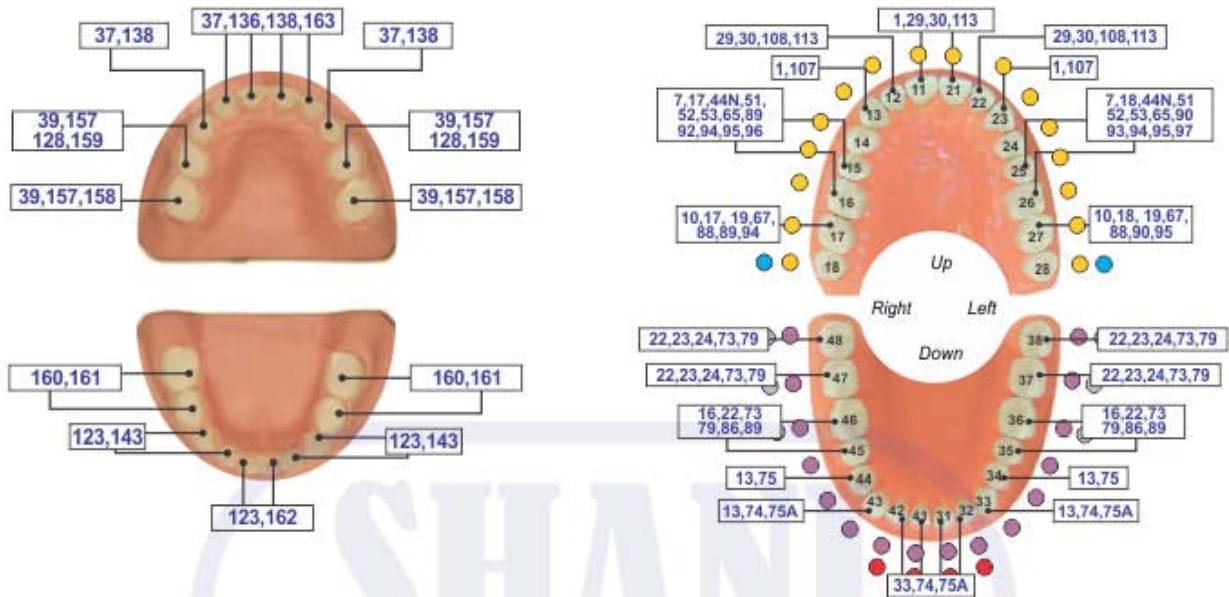

Dear Valued Buyers these are our Handle Styles



EXTRACTING FORCEPS (English Pattern)

- Щипцы экстракционные (английская форма)
- Daviers (Forme Anglaise)
- Zahnzangen (Englische Form)
- Щипці екстракційні (англійська форма)
- Forceps de Extracción (Forme Inglesa)
- استخراج الملقط (نمط اللغة الإنجليزية)

Function: To remove teeth from bony socket



DE-001
Fig. 1
Upper Centrals
and Canines



DE-002
Fig. 2
Upper Laterals
and Canines



DE-003
Fig. 4
Lower Incisors
and Canines



DE-004
Fig. 7
Upper Premolars



DE-005
Fig. 8
Lower Premolars



DE-006
Fig. 13
Lower Premolars



DE-007
Fig. 17
Upper Molars,
Right



DE-008
Fig. 18
Upper Molars, Left



DE-009
Fig. 21
Lower Molar



DE-010
Fig. 22
Lower Molar



Straight extracting forceps for upper incisors and canines



Straight extracting forceps for upper incisors and canines



Straight extracting forceps for upper incisors and canines

EXTRACTING FORCEPS (English Pattern)

- Щипцы экстракционные (английская форма)
- Щипці екстракційні (англійська форма)
- Daviers (Forme Anglaise)
- Forceps de Extracción (Forme Inglesa)
- Zahnzangen (Englische Form)
- استخراج الملقط (تمط اللغة الإنجليزية)

Function: To remove teeth from bony socket



DE-011
18A
upper molars



DE-012
19
upper third molars



DE-013
20
lower third molar



DE-014
24
lower molar, right



DE-015
29
upper roots



DE-016
30
Upper Roots



DE-017
33
lower roots



DE-018
33A
Lower Roots



DE-019
33M
Lower roots
with long beak



DE-020
46L



DE-021
51
Upper Roots



DE-022
51A
Upper Roots



Straight extracting forceps for upper incisors and canines



Straight extracting forceps for upper incisors and canines



Straight extracting forceps for upper incisors and canines

EXTRACTING FORCEPS (English Pattern)

- Щипцы экстракционные (английская форма)
- Щипці екстракційні (англійська форма)
- Daviers (Forme Anglaise)
- Forceps de Extracción (Forme Inglesa)
- Zahnzangen (Englische Form)
- استخراج الملقط (نمط اللغة الإنجليزية)

Function: To remove teeth from bony socket

WISDOM EXTRACTING FORCEPS



DE-023
Routerier
(# 22 1/2 L)
lower molars and
wisdoms, left



DE-024
Routerier
(# 22 1/2 R)
lower molars and
wisdoms, right



DE-029
51AL



DE-025
Routerier
(# 33 1/2 L)
lower molar and
wisdom roots, left



DE-026
Routerier
(# 33 1/2 R)
lower molar and
wisdom roots, right



*Routerier extracting forceps for lower molars
and third molars, right*



DE-030
67
Upper Third Molars



DE-027
Fig. 186L
lower molars



DE-028
Fig. 186R
lower molars



DE-031
67A
Upper Third Molars



Angled extracting forceps for upper roots

DE-032
79
Lower Third Molars



EXTRACTING FORCEPS (English Pattern)

- Щипцы экстракционные (английская форма)
- Daviers (Forme Anglaise)
- Zahnzangen (Englische Form)
- Щипці екстракційні (англійська форма)
- Forceps de Extracción (Forme Inglesa)
- استخراج الملقط (تمط اللغة الإنجليزية)



**DE-033
73**
Lower Molars



**DE-034
73 A**
lower molars



**DE-035
73 S**



**DE-036
74**
Lower Roots



**DE-037
74N**
Lower Roots



**DE-038
75**
Lower Premolars



**DE-039
86A**
Lower Molars



**DE-040
86B**
lower molars



**DE-041
86C**
lower molars



**DE-042
87**
Lower Molars



**DE-043
89**
Upper Molars,
Right



**DE-044
90**
Upper Molars,
Left



Straight extracting forceps for upper incisors and canines



Straight extracting forceps for upper incisors and canines



Straight extracting forceps for upper incisors and canines

EXTRACTING FORCEPS (English Pattern)

- Щипцы экстракционные (английская форма)
- Daviers (Forme Anglaise)
- Zahnzangen (Englische Form)
- Щипці екстракційні (англійська форма)
- Forceps de Extracción (Forme Inglesa)
- استخراج الملقط (نمط اللغة الإنجليزية)

DE-TRAUMATIC EXTRACTION

Improved tapered beaks for complete root contact. Cross serrations. Deep Gripe Extracting Forceps



- No Fracture
- No Tissue Damage
- Extraction With Easy



Thin Tip

DE-045
34

Upper incisors and premolars deep-gripping



Wide Tip

DE-046
34A

Upper centrals / cains deep-gripping



Thin Tip

DE-047
Fig. 35

upper permolars deep-gripping



Wide Tip

DE-048
35A

Upper incisors and premolars deep-gripping



Thin Tip

DE-049
36

Lower premolars deep-gripping



Wide Tip

DE-050
36A

Lower premolars deep-gripping



DE-051
336

lower permolars deep-gripping



DE-052
F-7C

lower molar



DE-053
9

Apex Forceps Lower Universal Deep Root Pick



DE-054
79N

Lower third molars deep-gripping



DE-055
79

Lower Thrid Molars



Function:

Extraction forceps are used to further loosen teeth by rotational and tilting movements and finally to extract the teeth in combination with a fulcrum.

EXTRACTING FORCEPS (English Pattern)

- Щипцы экстракционные (английская форма)
- Щипці екстракційні (англійська форма)
- Daviers (Forme Anglaise)
- Forceps de Extracción (Forme Inglesa)
- Zahnzangen (Englische Form)
- استخراج الملقط (تمط اللغة الإنجليزية)

DEEP ROOT PICK FORCEPS



DE-056
146

Apex Forceps Lower Root
Deep Root Pick



DE-057
153

Apex Forceps Upper Root
Deep Root Pick



DE-058
149

Apex Forceps Upper Root
Deep Root Pick



DE-061
Fig. 44



DE-060
Fig. 44Z



DE-059
Fig. 45Z



DE-062
46XL
Apex Forceps Lower Root
Deep Root Pick



DE-063
67
Upper Third Molars



DE-064
67A
Upper Third Molars



DE-065
67N
Lower third molars
deep-gripping



DE-066
331
upper roots
deep-gripping



forceps for upper incisors, premolars and roots



EXTRACTING FORCEPS (English Pattern)

- Щипцы экстракционные (английская форма)
- Daviers (Forme Anglaise)
- Zahnzangen (Englische Form)

- Щипці екстракційні (англійська форма)
- Forceps de Extracción (Forme Inglesa)
- استخراج الملقط (نمط اللغة الإنجليزية)



Fig. 1
upper
laterals
and canines



DE-067
Set of 10 Pieces
Fig. 1
Fig. 7
Fig. 13
Fig. 17
Fig. 18
Fig. 22
Fig. 51A
Fig. 67
Fig. 74N
Fig. 79

Fig. 7
upper premolars



Fig. 13
lower premolars



Fig. 17
upper molars, right



Fig. 18
upper molars, left



Fig. 22
lower roots



Fig. 51A
upper roots



Fig. 67
upper third molars



Fig. 74N
lower molar



Fig. 79
lower third molars



Extracting forceps for upper roots



EXTRACTING FORCEPS

- Щипцы экстракционные
- Daviers
- Zahnzangen
- Щипці екстракційні
- Forceps de Extracción
- استخراج الملقط

Pediatric Tooth Extracting Forceps Set



DE-069
English Pattern Klein #51S
Pedodontic Upper root



DE-068
English Pattern Klein #137
Pedodontic, Upper Incisors Spring handle



DE-072
English Pattern Klein #5
Pedodontic Lower Incisors.



DE-070
English Pattern Klein #139
Pedodontic Upper Premolars



DE-075
Fig. # 01 to 07
Set of 7 Pieces



DE-073
English Pattern Klein #7
Pedodontic Lower Roots,



DE-071
English Pattern Klein #3
Pedodontic Upper Molars Universal

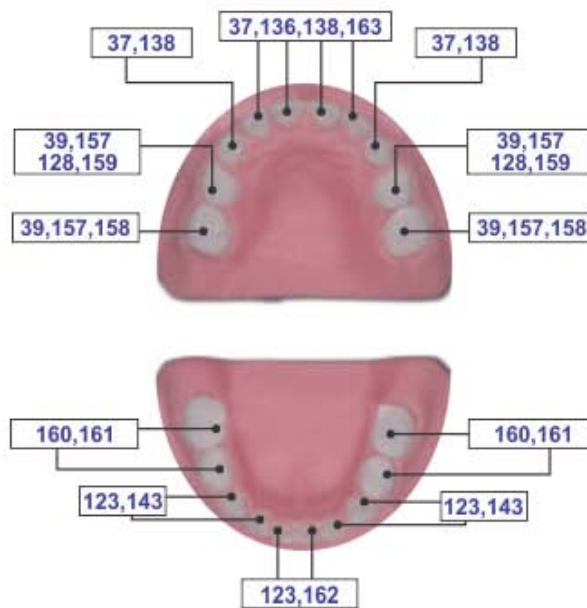

DE-074
English Pattern Klein #6
Pedodontic Lower Molars, Spring Handle



Witzel
DE-076
170mm
Upper roots, Universal



Witzel
DE-077
165mm
Lower roots, Universal



DE-078
#400(300)
165mm
Upper roots, Universal



DE-079
#401(301)
160mm
Lower roots, Universal



DE-080
Witzel Forceps With Gold
Set of 3 Pcs



DE-084
Witzel Forceps With Hole And Screw Pattern
Set of 3 Pcs



DE-088
Witzel Forceps With Anatomical Handle
Set of 3 Pcs



DE-081
#401(301)
160mm
Lower roots, Universal



DE-085
#401(301)
160mm
Lower roots, Universal



DE-089
#401(301)
160mm
Lower roots, Universal



DE-082
#400(300)
165mm
Upper roots, Universal



DE-086
#400(300)
165mm
Upper roots, Universal



DE-090
#400(300)
165mm
Upper roots, Universal



Witzel
DE-083
165mm
Lower roots, Universal



Witzel
DE-087
165mm
Lower roots, Universal



Witzel
DE-091
165mm
Lower roots, Universal

ROOTS SPLINTER FORCEPS

- Щипцы для удаления корневых осколков
- Pincas Fragments
- Wurzelsplitterzangen
- Щипці для видалення корневих осколків
- Pinzas Para Fragmentos
- جوار مشقة المنقط



DE-092
Splinter Forceps
15.5cm



Stieglitz Root Splinter Forceps



DE-093
Splinter Forceps
15.5cm 45°

SHANI
Industries



DE-094
Stieglitz
Root Fragments



DE-095
Stieglitz
Root Fragments



DE-096
Stieglitz Splinter Forceps
140mm 90°



DE-097
Stieglitz Splinter Forceps
140mm Straight

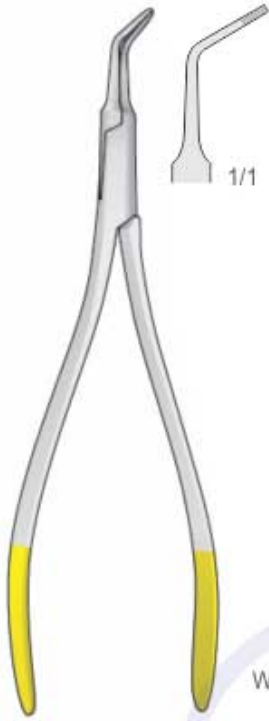

DE-098
130mm

With Diamond

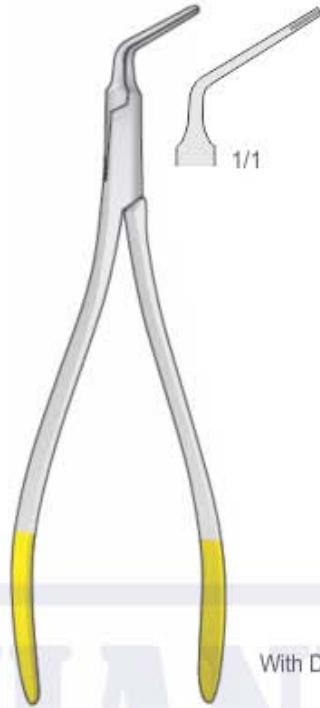

DE-099
130mm

With Diamond

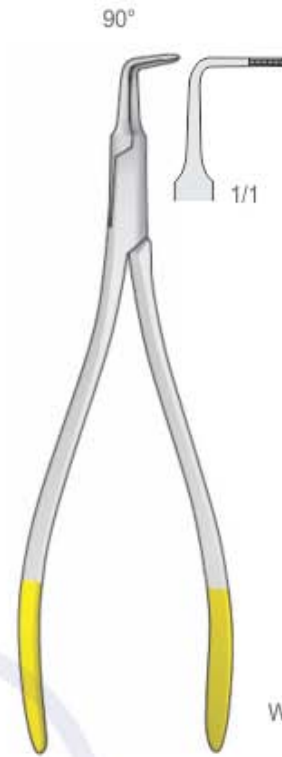

DE-100
125mm

With Diamond



DE-101
130mm



DE-102
130mm



DE-103
125mm

EXTRACTING FORCEPS (American Pattern)

- Щипцы экстракционные (американская форма)
- Daviers - forme américaine
- Férceps de extracción - forma americana
- Щипці екстракційні (американська форма)
- Pinzere per estrazione - forma americana
- استخراج الملقط (النمط الأمريكي)



DE-104
1STD
Winter
upper centrals and canines

DE-105
Fig. 1
upper incisors
and roots

DE-106
Cryer
Fig. 150

EXTRACTING FORCEPS (American Pattern)

- Щипцы экстракционные (американская форма)
- Щипці екстракційні (американська форма)
- Daviers - forme américaine
- Pinzere per estrazione - forma americana
- Fórceps de extracción - forma americana
- استخراج الملقط (النمط الأمريكي)



DE-108

Fig. 62

incisors, premolars,
deciduous teeth

DE-109

10S

upper roots

DE-110

17

lower molars

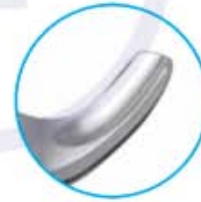
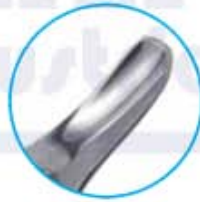

DE-111

Harris

Fig. 18R

DE-112

Harris

Fig. 18L

DE-107

Fig. 150A

Cryer

upper incisors, premolars, roots

EXTRACTING FORCEPS (American Pattern)

- Щипцы экстракционные (американская форма)
- Daviers - forme américaine
- Férceps de extracción - forma americana
- Щипці екстракційні (американська форма)
- Pinzere per estrazione - forma americana
- استخراج الملقط (النمط الأمريكي)

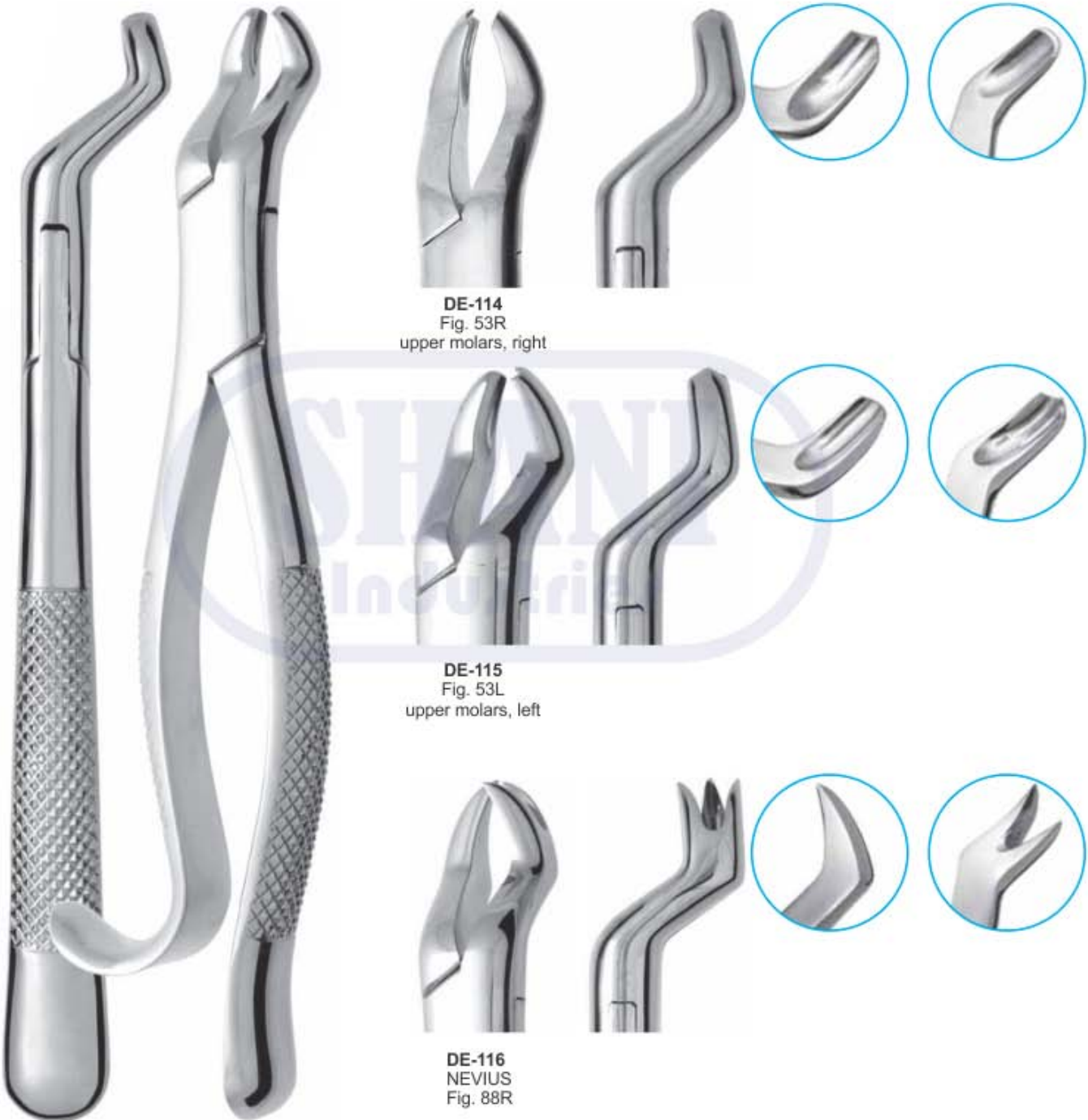

DE-114
Fig. 53R
upper molars, right

DE-115
Fig. 53L
upper molars, left

DE-116
NEVIUS
Fig. 88R

DE-113
Fig. 210
upper third molars

EXTRACTING FORCEPS (American Pattern)

- Щипцы экстракционные (американская форма)
- Щипці екстракційні (американська форма)
- Daviers - forme américaine
- Pinzere per estrazione - forma americana
- Fórceps de extracción - forma americana
- استخراج الملقط (النمط الأمريكي)



DE-117
Fig. 24
upper molars



DE-118
210S
upper third molars



DE-119
210H
upper third molars



DE-120
286
Upper Roots,
Premolars, Incisors



DE-121
99C
Kells
upper incisors,
canines, premolars



DE-122
222
lower third molars



DE-123
286
Lower Molar

EXTRACTING FORCEPS (American Pattern)

- Щипцы экстракционные (американская форма)
- Dавiers - forme américane
- Fórceps de extracción - forma americana
- Щипці екстракційні (американська форма)
- Pinzere per estrazione - forma americana
- استخراج الملقط (النمط الأمريكي)



DE-124
Nevius
Fig. 88L
upper molars, left



DE-125
Fig. 65
upper incisors
and roots



DE-126
Parmly Fig. 32A
upper premolars
and roots



DE-127
Parmly Fig. 32
upper premolars
and molars

EXTRACTING FORCEPS (American Pattern)

- Щипцы экстракционные (американская форма)
- Щипці екстракційні (американська форма)
- Daviers - forme américaine
- Pinzere per estrazione - forma americana
- Fórceps de extracción - forma americana
- استخراج الملقط (النمط الأمريكي)

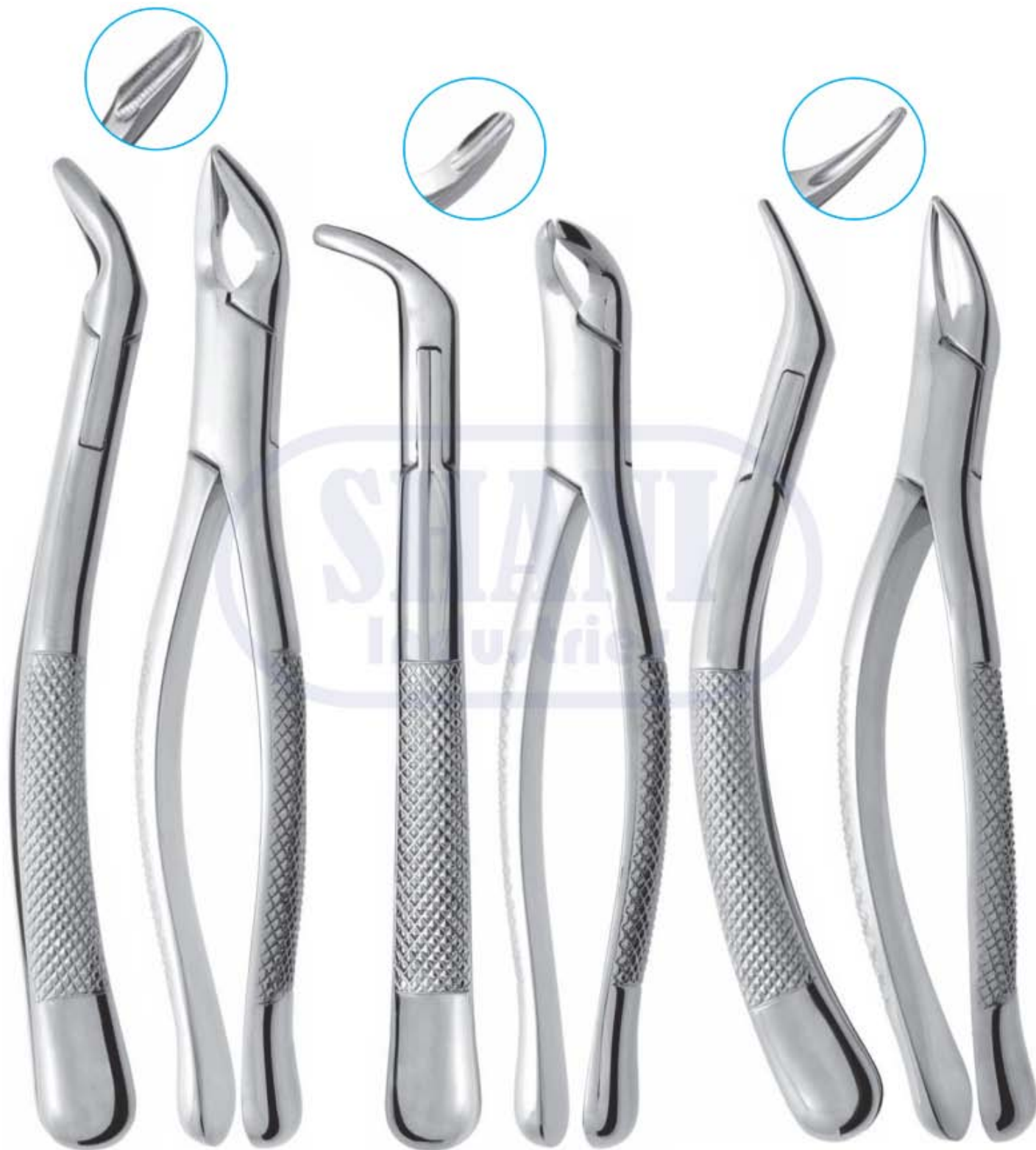

DE-128
COHEN
universal

DE-129
Fig. 203
lower incisors
and roots

DE-130
Tomes Fig. 69
upper and lower
roots

EXTRACTING FORCEPS (American Pattern)

- Щипцы экстракционные (американская форма)
- Щипці екстракційні (американська форма)
- Daviers - forme américaine
- Pinzere per estrazione - forma americana
- Fórceps de extracción - forma americana
- استخراج الملقط (النمط الأمريكي)



EXTRACTING FORCEPS (American Pattern)

- Щипцы экстракционные (американская форма)
- Щипці екстракційні (американська форма)
- Daviers - forme américaine
- Pinzere per estrazione - forma americana
- Fórceps de extracción - forma americana
- استخراج الملقط (النمط الأمريكي)



DE-136
Hull
Fig. 101
Deciduous teeth

DE-137
Cryer
Fig. 150S
upper teeth,
for children

DE-138
Fig. 150 AS

EXTRACTING FORCEPS (American Pattern)

- Щипцы экстракционные (американская форма)
- Daviers - forme américaine
- Férceps de extracción - forma americana
- Щипці екстракційні (американська форма)
- Pinzere per estrazione - forma americana
- استخراج الملقط (النمط الأمريكي)



DE-139
Cryer
Fig. 151
lower teeth,
for children

DE-140
Fig. 151 S
lower incisors,
premolars, roots

DE-141
Fig. 151 AS

EXTRACTING FORCEPS (American Pattern)

- Щипцы экстракционные (американская форма)
- Щипці екстракційні (американська форма)
- Daviers - forme américaine
- Pinzere per estrazione - forma americana
- Fórceps de extracción - forma americana
- استخراج الملقط (النمط الأمريكي)



DE-142
16S
lower molars for children



DE-143
17S
lower molars



DE-144
23 S
Lower molars

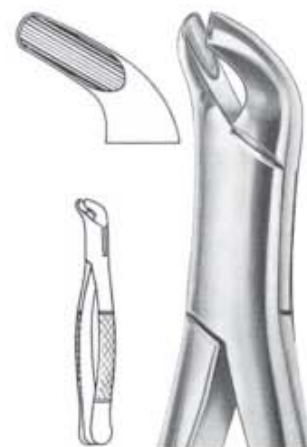

DE-145
27
lower molars



DE-146
18LS
upper molars left



DE-147
18RS
upper molars right

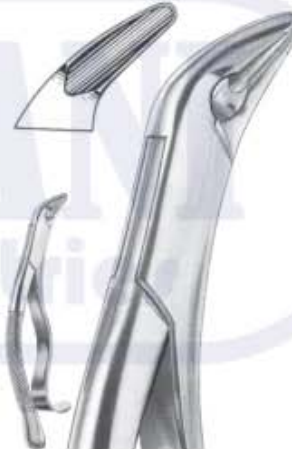

DE-148
85 Tomas
lower canines, premolars and molars



DE-149
85A Tomas
lower canines, premolars and molars



DE-150
69S
upper and lower roots



DE-151
99A Kells
upper incisors, canines, premolars



DE-152
217
lower molars

EXTRACTING FORCEPS (American Pattern)

- Щипцы экстракционные (американская форма)
- Dавiers - forme américaine
- Fórceps de extracción - forma americana
- Щипці екстракційні (американська форма)
- Pinzere per estrazione - forma americana
- استخراج الملقط (الأمريكي)



DE-153
#10 SK
Upper Molars Sup



DE-154
#17 SK Universal
Lower Molars



DE-155
#23 SK Universal
Upper Molars



DE-156
#69 SK Tomas
upper and lower roots



DE-157
#99 SK
upper incisors,
canines, premolars



DE-158
#150 SK
upper incisors,
premolars, roots



DE-159
#151 SK
lower incisors,
premolars, roots



DE-160
#222 SK
lower third molars

EXTRACTING FORCEPS (American Pattern)

- Щипцы экстракционные (американская форма)
- Щипці екстракційні (американська форма)
- Daviers - forme américaine
- Pinzere per estrazione - forma americana
- Fórceps de extracción - forma americana
- استخراج الملقط (النمط الأمريكي)



DE-161
Fig. 1
Upper Anterior

DE-162
Lower Molar
Fig. 23 Cow Horn



DE-163
Fig. 74
Lower Anterior



DE-164
Fig. 88L
Upper Molar Left



DE-165
Fig. 88R
Upper Molar Right



DE-166
Fig. 74
Lower Anterior



DE-167
Fig. 106
Lower Incisors



DE-168
Fig. 174
Extra Narrow
Lower Anterior
Apical Retention
Forceps



DE-169
Fig. 859
Lower Molars
Roots



EXTRACTING FORCEPS (American Pattern)

- Щипцы экстракционные (американская форма)
- Щипці екстракційні (американська форма)
- Daviers - forme américaine
- Pinzere per estrazione - forma americana
- Fôrceps de extracción - forma americana
- استخراج الملقط (النمط الأمريكي)

Carbide Diamond Coated Point



DE-170
150 T.C.
Carbide Serrated Beak
Upper Incisors, Cuspids,
Bicuspid & Roots,
Universal



DE-171
151 T.C.
Carbide Serrated Beak
Lower Incisors, Cuspids,
Bicuspid & Roots, Universal



DE-172
1STD T.C.
Carbide Serrated Beak
Upper Incisors, Cuspids,



DE-173
17 T.C.
Carbide Serrated Beak
1st & 2nd Lower Molars,
Universal



DE-174
53L T.C.
Carbide Serrated Beak
1st & 2nd Upper Molars,
Left



DE-175
53R T.C.
Carbide Serrated Beak
1st & 2nd Upper Molars,
Right



DE-176
65 T.C.
Carbide Serrated Beak
Upper Incisors, Roots &
Fragments



DE-177
69 T.C.
Carbide Serrated Beak
Upper & Lower Fragments
And Roots



DE-178
150S T.C. Pedro forcep
Carbide Serrated Beak
Pedo, Upper Primary Teeth
and Roots, Universal



DE-179
151S T.C. Pedro forcep
Carbide Serrated Beak
Pedo, Lower Primary Teeth
and Roots, Universal

BONE ROUNGER

- Костные кусачки
- Hohlmeißelzangen
- Pincès-gouges
- Кусачки для кісток
- Pinzas-gubias
- روتجورس العظام



DE-180
Blumenthal
15cm



DE-181
Blumenthal
15cm



DE-182
Blumenthal
15cm



DE-183
Friedman
14cm



DE-184
Friedman
14.5cm



DE-185
Micro-Friedman
14cm



DE-186
Micro-Friedman
15cm



DE-187
Micro-Friedman
16cm



DE-188
Kleinert-Kutz
18.5cm



DE-189
Beyer
18.5cm



DE-190
Mead 1A
18.5cm



DE-191
Luer
18.5cm

EXTRACTING FORCEPS (English Pattern)

- Щипцы экстракционные (английская форма)
- Щипці екстракційні (англійська форма)
- Daviers (Forme Anglaise)
- Forceps de Extracción (Forme Inglesa)
- Zahnzangen (Englische Form)
- استخراج الملقط (تمط اللغة الإنجليزية)

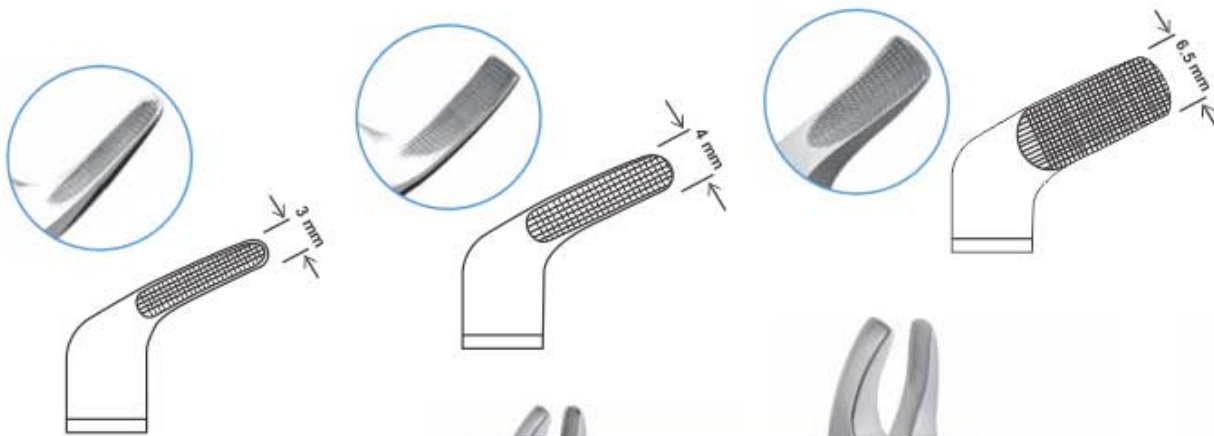

DE-192
Meissner
Extracting Forceps



DE-193
Meissner
Extracting Forceps



DE-194
Meissner
Extracting Forceps



DE-195
Comellas Forceps
Anatomical Handle

DENTAL SYRINGES

- Шприцы стоматологические карпульные
- Siringues à usage dentaire
- Dentalspritzen
- Шприці стоматологічні карпульні
- Jeringas dentales
- المحاقن الأسنان



DE-196 1.8ml
DE-197 2.2ml



DE-198 1.8ml
DE-199 2.2ml



DE-200 1.8ml
DE-201 2.2ml



DE-202 1.8ml
DE-203 2.2ml



DE-204 1.8ml
DE-205 2.2ml



DE-206 1.8ml
DE-207 2.2ml



DE-208
1001
Intraligamental
Anesthesia
Syringe in
Black Colour



DE-209 1.8ml
DE-210 2.2ml
Angled



DE-211
Aluminium - Dark 1.8 ml

- | | | | |
|---|---|---|---|
|  |  |  |  |
| DE-212
Aluminium -
Silver 1.8 ml | DE-213
Aluminium -
Orange 1.8 ml | DE-214
Aluminium -
Green 1.8 ml | DE-215
Aluminium -
Blue 1.8 ml |



Type C
DE-216 1.8ml
DE-217 2.2ml



Type C
DE-218 1.8ml
DE-219 2.2ml



2-Ring
DE-220 1.8ml
DE-221 2.2ml



Aspirating Syringe
DE-222 1.8mm
DE-223 2.2mm



Cartridge Syringe
DE-224 1.8mm
DE-225 2.2mm



Cartridge Syringe
DE-226 1.8mm
DE-227 2.2mm



Cartridge Syringe
DE-228 1.8mm
DE-229 2.2mm

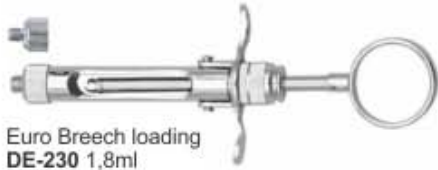

Euro Breech loading
DE-230 1.8ml
DE-231 2.2ml

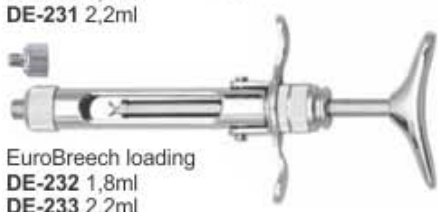

EuroBreech loading
DE-232 1.8ml
DE-233 2.2ml



Manual Aspirating Syringe
DE-234 1.8ml
DE-235 2.2ml



Quatro
DE-236 1.8ml
DE-237 2.2ml



Trio
DE-238 1.8ml
DE-239 2.2ml



Swedish Type
DE-240 1.8ml
DE-241 2.2ml



Ject Ultima
DE-242 1.8ml
DE-243 2.2ml
Injects 0.05 ml with every click Supplied with
angled and straight tubes



Ject angled
DE-244 1.8ml
DE-245 2.2ml

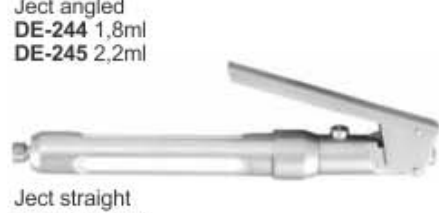

Ject straight
DE-246 1.8ml
DE-247 2.2ml



Disc System
DE-248 1.8ml
DE-249 2.2ml



Disc System
DE-250 1.8ml

EXTRACTING FORCEPS SET

Извлечение щипцов
Ensemble de pinces d'extraction
• Zange sammeln

• Витягуючий комплект щипців
• Extracción del conjunto de fórceps
• استخراج ملقط مجموعة



DE-251
Extracting Forceps
Set of 10 Pieces
Extracting Forceps Fig. 2
Extracting Forceps Fig. 7
Extracting Forceps Fig. 13
Extracting Forceps Fig. 17
Extracting Forceps Fig. 18
Extracting Forceps Fig. 22
Extracting Forceps Fig. 33
Extracting Forceps Fig. 51A
Extracting Forceps Fig. 67A
Extracting Forceps Fig. 79



DE-252
Extracting Forceps
Set of 10 Pieces
Extracting Forceps Fig. 2
Extracting Forceps Fig. 7
Extracting Forceps Fig. 13
Extracting Forceps Fig. 17
Extracting Forceps Fig. 18
Extracting Forceps Fig. 22
Extracting Forceps Fig. 33
Extracting Forceps Fig. 51A
Extracting Forceps Fig. 67A
Extracting Forceps Fig. 79



DE-253
Extracting Forceps
Set of 13 Pieces
Extracting Forceps Fig. 2
Extracting Forceps Fig. 7
Extracting Forceps Fig. 13
Extracting Forceps Fig. 17
Extracting Forceps Fig. 18
Extracting Forceps Fig. 22
Extracting Forceps Fig. 33
Extracting Forceps Fig. 51A
Extracting Forceps Fig. 67A
Extracting Forceps Fig. 79
Extracting Forceps Fig. 86C
Extracting Forceps Fig. 89
Extracting Forceps Fig. 90



DE-254
Extracting Forceps Children Pattern
Set of 10 Pieces
Extracting Forceps Fig. 13S
Extracting Forceps Fig. 22S
Extracting Forceps Fig. 30S
Extracting Forceps Fig. 33S
Extracting Forceps Fig. 37
Extracting Forceps Fig. 38
Extracting Forceps Fig. 39
Extracting Forceps Fig. 39L
Extracting Forceps Fig. 39R
Extracting Forceps Fig. 51S



DE-255
Extracting Forceps English adult Adult
Set of 10 Pcs



DE-256
Extracting Forceps American Adult
Set of 10 Pcs



DE-257
Extracting Forceps American Adult
Set of 8 Pcs



DE-258
Extracting Forceps Pedro
Set of 7 Pcs

ROOT ELEVATOR

FUNCTION OF ROOT ELEVATORS IN SURGERY

To Loosen Tooth or Root From Bony Socket Prior to Placement of The Extraction Forceps.

HANDLES FOR ROOT ELEVATORS POINTS A, B, C, D, E, F, G, H



ROOT ELEVATOR

- Elevator корневой экстракционный
- Elévateurs à racines
- Wurzelheber
- Elevator корневий екстракційний
- Elevadores para raices
- المصاعد الجذر

Function of Root Elevators:

To loosen tooth or root from bony socket prior to placement of the extraction forceps.

Apexo Root Elevators



Luxator Root Elevators



Bein Root Elevators

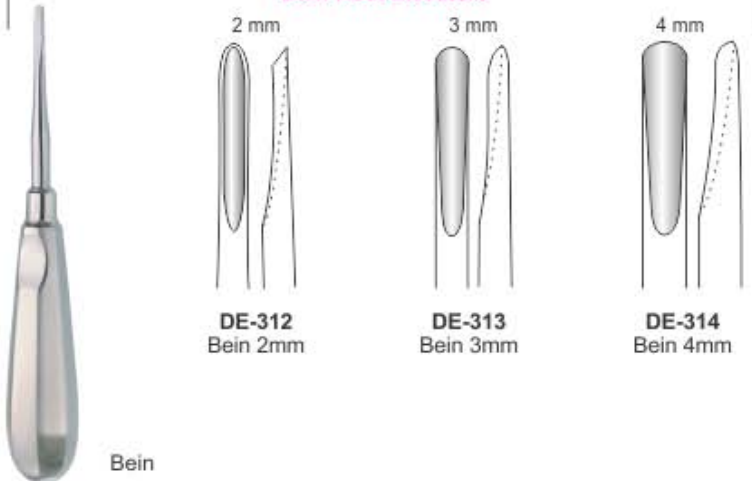

Seldin Root Elevators

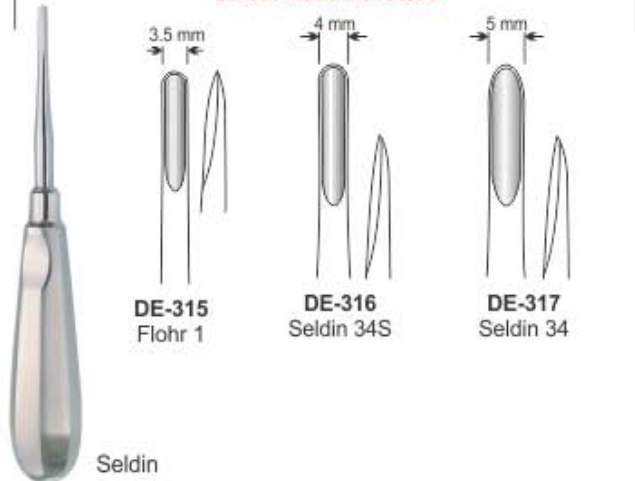

ROOT ELEVATOR

- Элеватор корневой экстракционный
- Elévateurs à racines
- Wurzelheber
- Слеватор корневий экстракційний
- Elevadores para raices
- المصاعد الجذر

FUNCTION: To loosen tooth or root from bony socket prior to placement of the extraction forceps.

Laxutor Root Elevators

Long Type



Laxutor Root Elevator



DE-318
Laxutor
1.5mm
Str.



DE-319
Laxutor
2mm
Str.



DE-320
Laxutor
3mm
Str.



DE-321
Laxutor
5mm
Str.



DE-322
Laxutor
3mm
Cvd.



DE-323
Laxutor
5mm
Cvd.



DE-324
Laxutor
3mm
Upper Angle



DE-325
Laxutor
3mm
Double Angle



DE-326
Laxutor
3mm
Str.



DE-327
Laxutor
5mm
Str.



ROOT ELEVATOR

- Элеватор корневой экстракционный
- Elévateurs à racines
- Wurzelheber
- Слеватор корневий экстракційний
- Elevadores para raices
- المصاعد الجذر

Laxutor Root Elevators

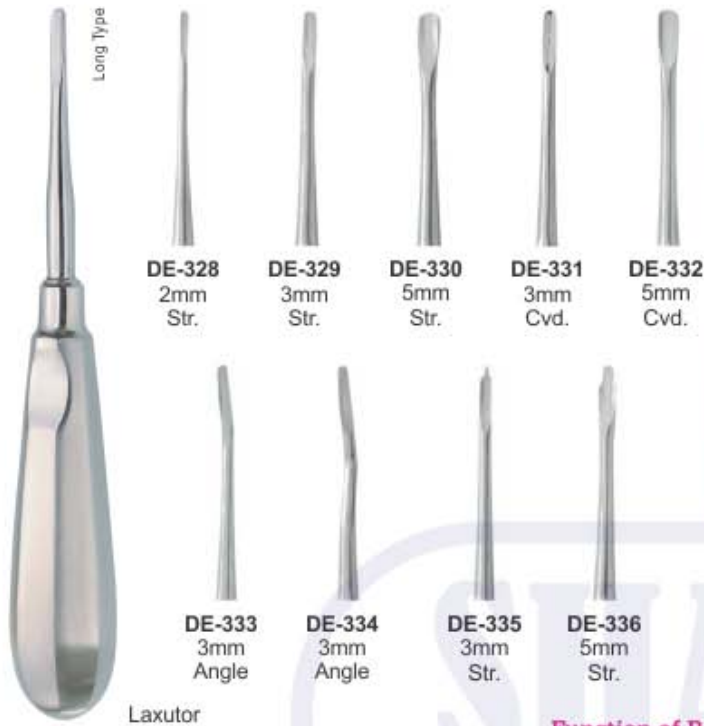

lower roots elevator



Upper root elevator with helicoidal tip

Luxator Roots Elevator



Function of Root Elevators:

To loosen tooth or root from bony socket prior to placement of the extraction forceps.

Apical Root Elevators

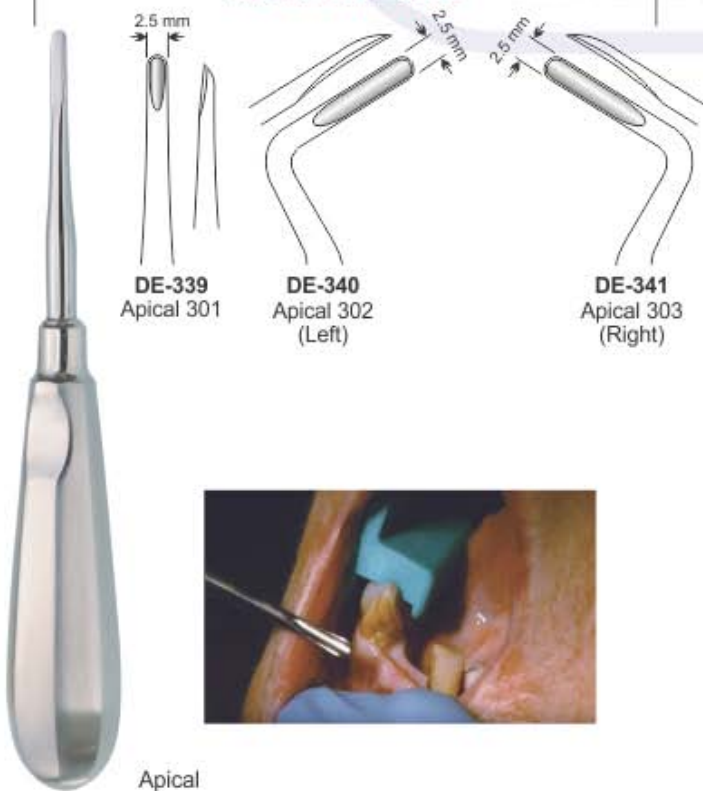

Apical

Apical Root Elevators

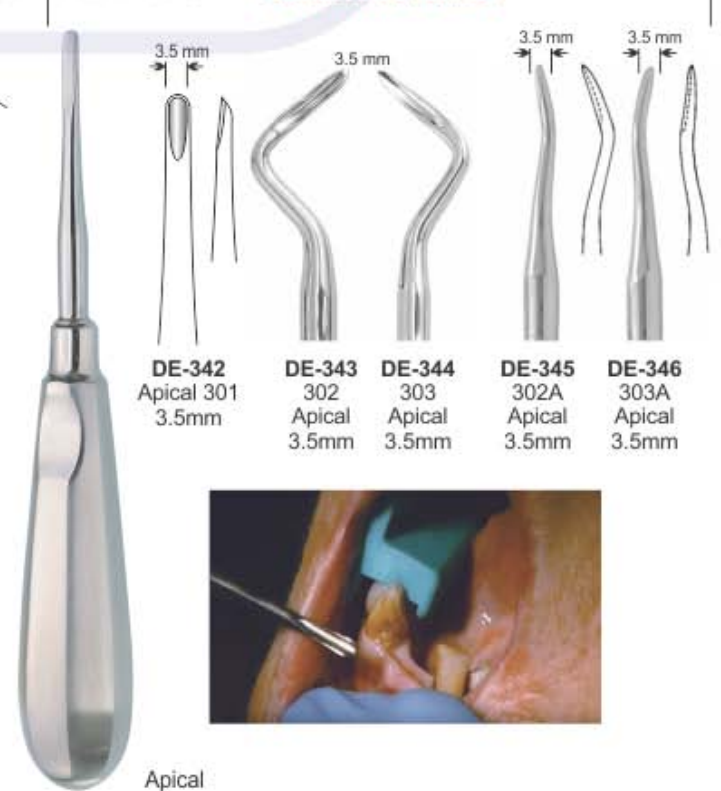

Apical

ROOT ELEVATOR

- Элеватор корневой экстракционный
- Elévateurs à racines
- Wurzelheber
- Слеватор корневий екстракційний
- Elevadores para raices
- المصاعد الجذر

FUNCTION: To Loosen Tooth or Root From Bony Socket Prior to Placement of The Extraction Forceps.

Cryer Root Elevators



Cryer Root Elevator



Cryer root or fragment elevator



Seldin root or fragment elevator

Seldin Root Elevators



Seldin



Cryer root or fragment elevator



Seldin root or fragment elevator

ROOT ELEVATOR

- Элеватор корневой экстракционный
 - Elévateurs à racines
 - Wurzelheber
- Elevator corneveeiey extraeekionnyy
 - Elevadores para raices
 - المصاعد الجذر

FUNCTION: To Loosen Tooth or Root From Bony Socket Prior to Placement of The Extraction Forceps.

Apical Root Elevators

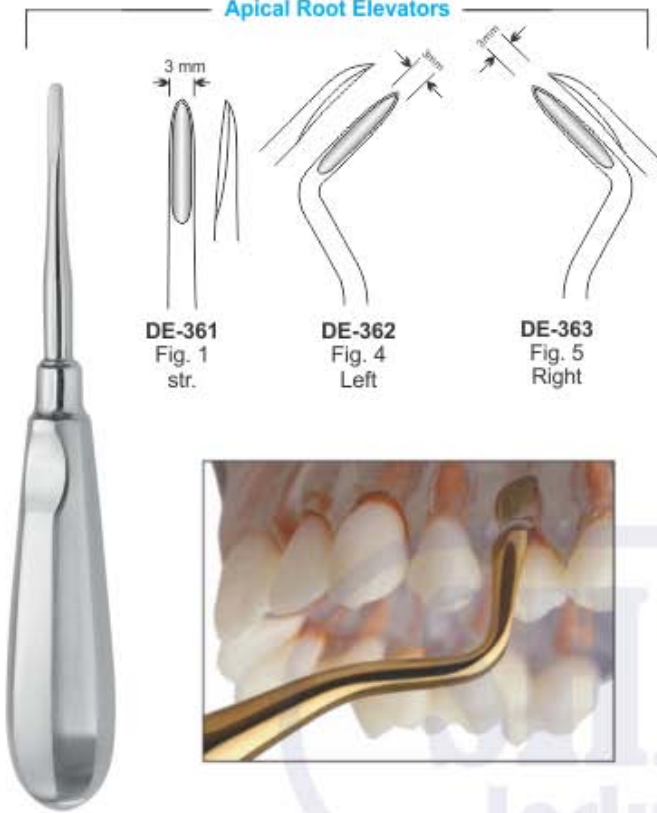

Apical Root Elevators

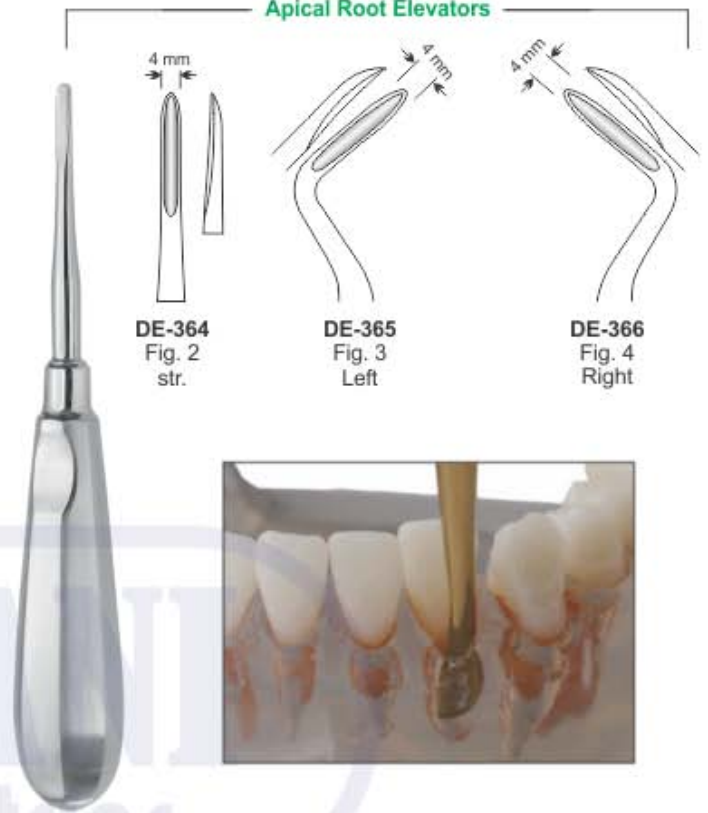

Flohr Root Elevators



Heidbrink Root Elevators

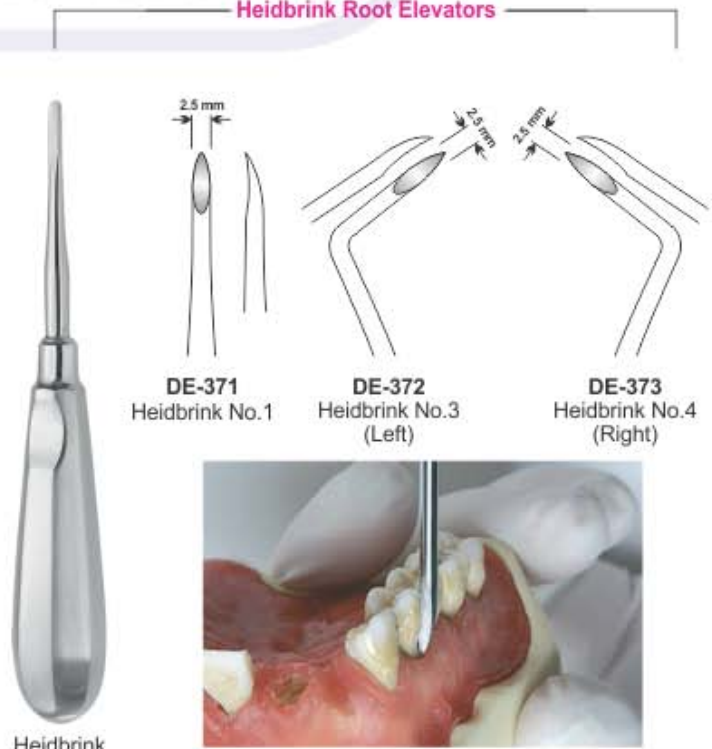

ROOT ELEVATOR

- Элеватор корневой экстракционный
- Elévateurs à racines
- Wurzelheber
- Слеватор корневий экстракційний
- Elevadores para raices
- المصاعد الجذر

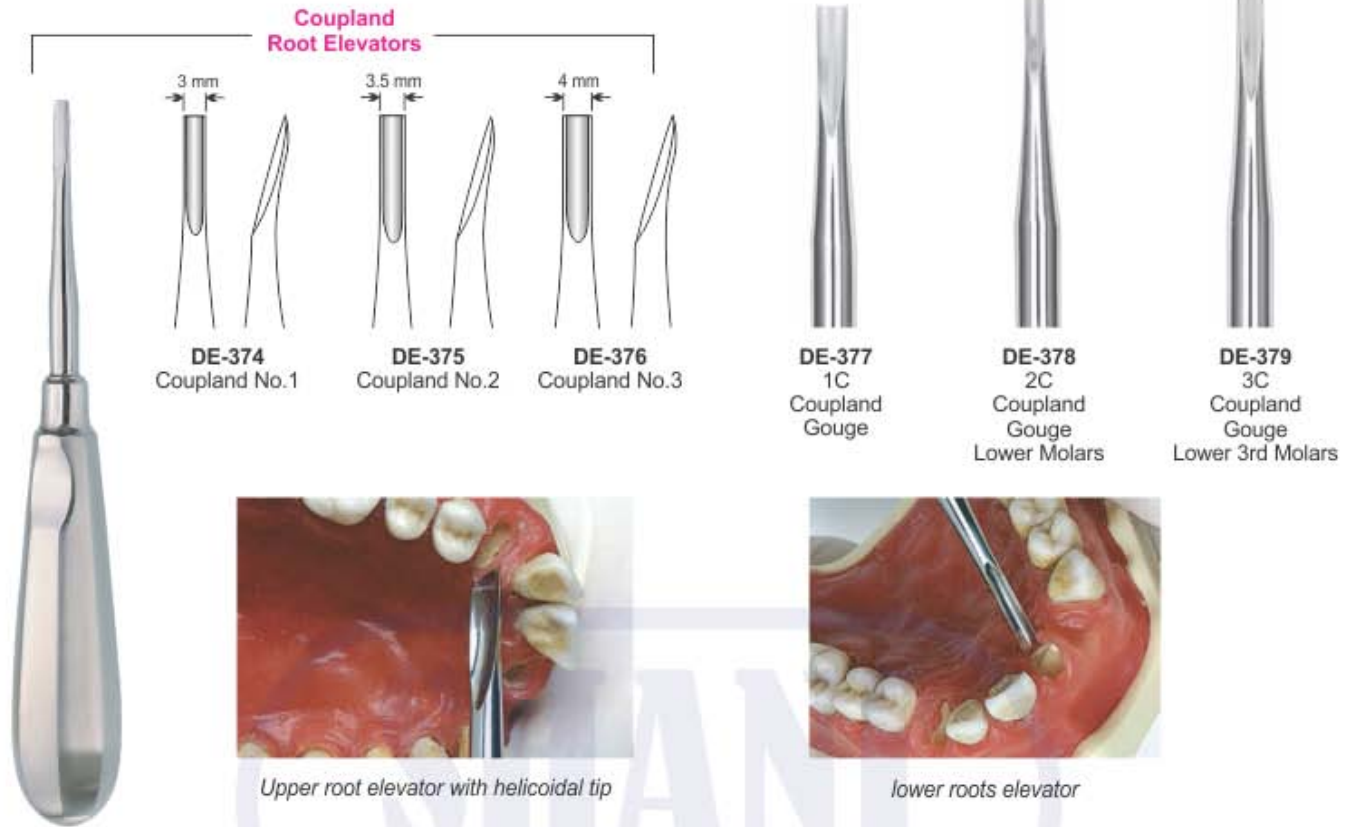

FUNCTION: To Loosen Tooth or Root From Bony Socket Prior to Placement of The Extraction Forceps.

ENGLISH PATTERNS

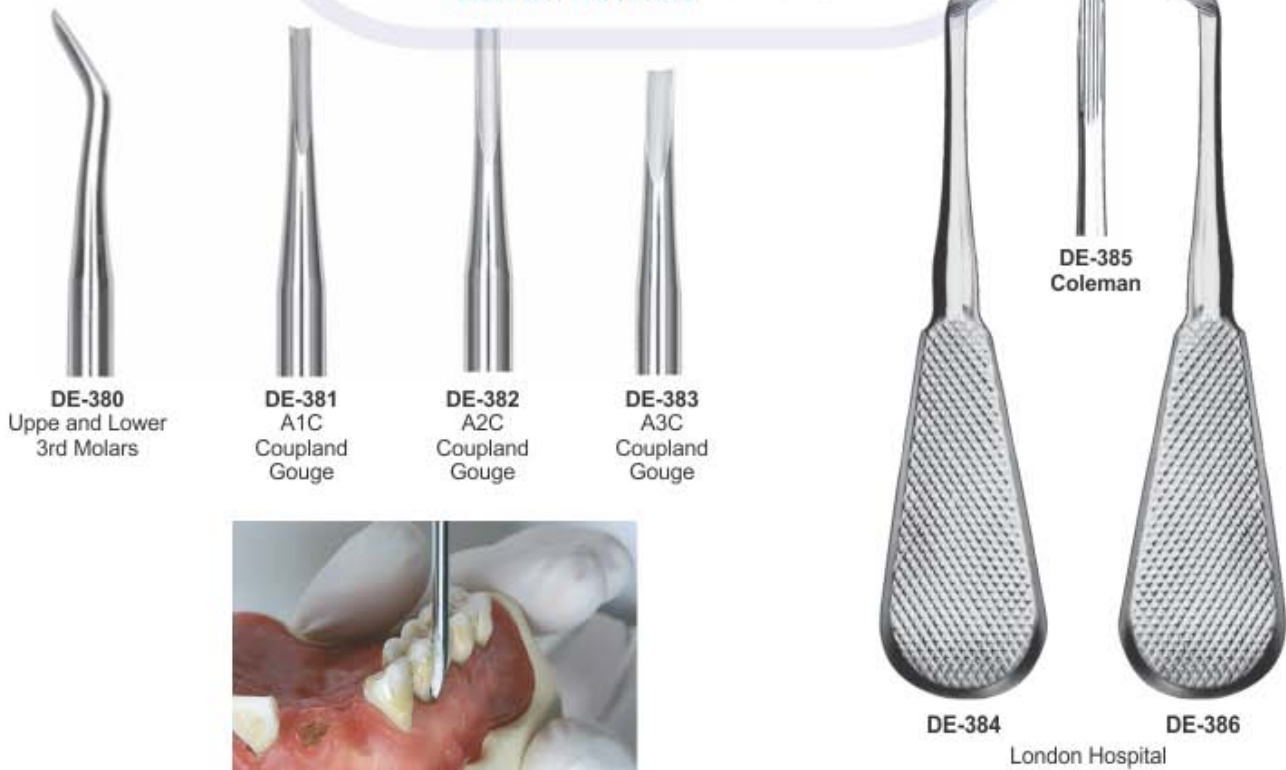

ROOT ELEVATOR

- Элеватор корневой экстракционный
- Elévateurs à racines
- Wurzelheber
- Слеватор корневий екстракційний
- Elevadores para raices
- المصاعد الجذر

Lindo Levian Root Elevators

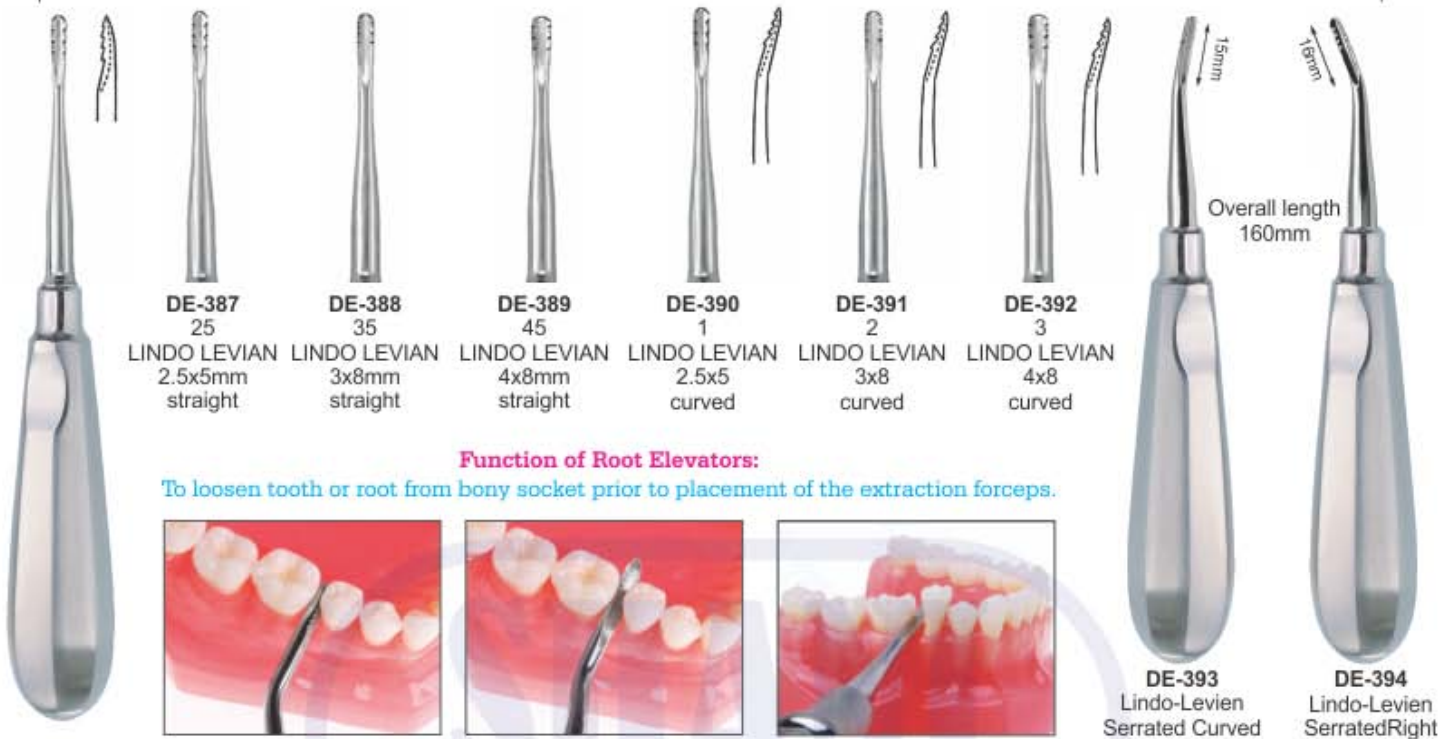

Function of Root Elevators:

To loosen tooth or root from bony socket prior to placement of the extraction forceps.

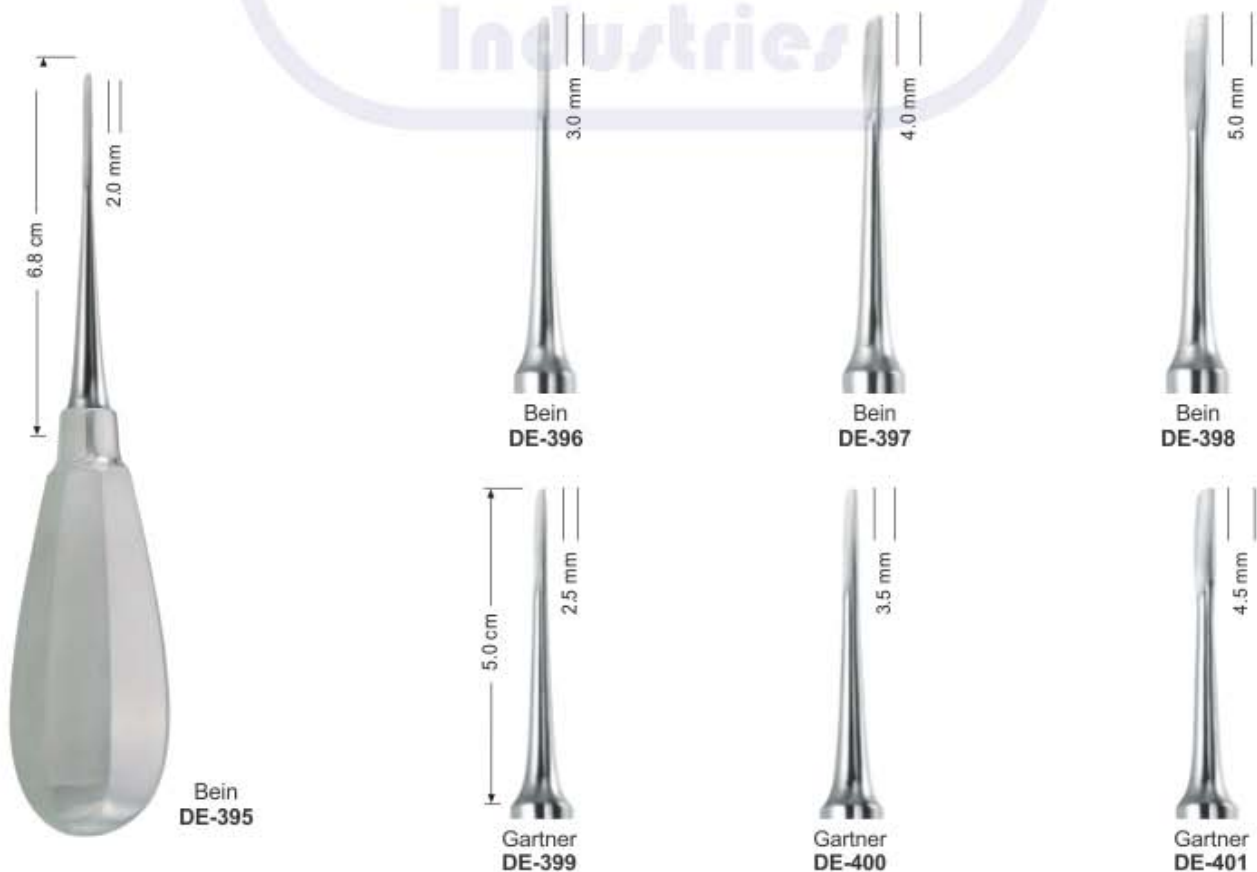

ROOT ELEVATOR

- Элеватор корневой экстракционный
- Elévateurs à racines
- Wurzelheber
- Слеватор корневий екстракційний
- Elevadores para raices
- المصاعد الجذر

Friedmann Roots Elevator



DE-402
Friedmann 4F
Str.

DE-403
Friedmann 5F
Left

DE-404
Friedmann 6F
Right

Luxating Elevator With Periotome Tip



DE-405
3mm Luxating
Elevator / Periotome

DE-406
4mm Luxating
Elevator / Periotome

DE-407
5mm Luxating
Elevator / Periotome

Wisdom Roots Elevator



DE-408
Wisdom
for 18 and 38

DE-409
Wisdom
for 28 and 48

Function of Root Elevators: To loosen tooth or root from bony socket prior to placement of the extraction forceps.

Bayonet Roots Elevator Set



DE-410
Left

DE-411
Right

DE-412
bayonet

DE-413
Curved

DE-414
Straight

ROOT ELEVATOR

- Элеватор корневой экстракционный
- Elévateurs à racines
- Wurzelheber
- Слеватор корневий екстракційний
- Elevadores para raices
- المصاعد الجذر

Miller Root Elevators



Function of Root Elevators: To loosen tooth or root from bony socket prior to placement of the extraction forceps.

Claw-Lift Roots Elevator

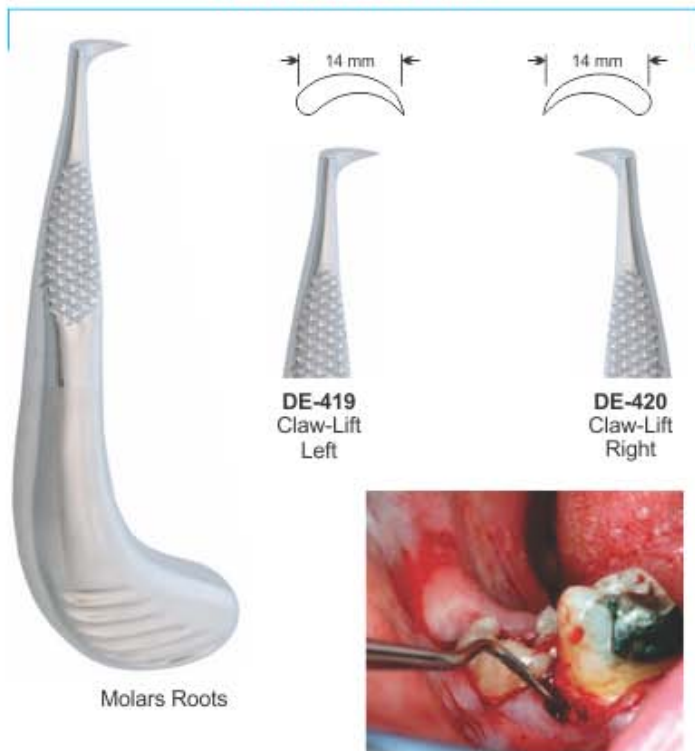

Schlemmer Roots Elevator



EXPLORERS

- Зонды
- Sondes
- Zahnsonden
- Зонди
- Sondas
- المستكشفين

Single Ended Probe Solid Handle 4.5mm Length 150mm



Explorers-Single-End

Double-Ended Explorers

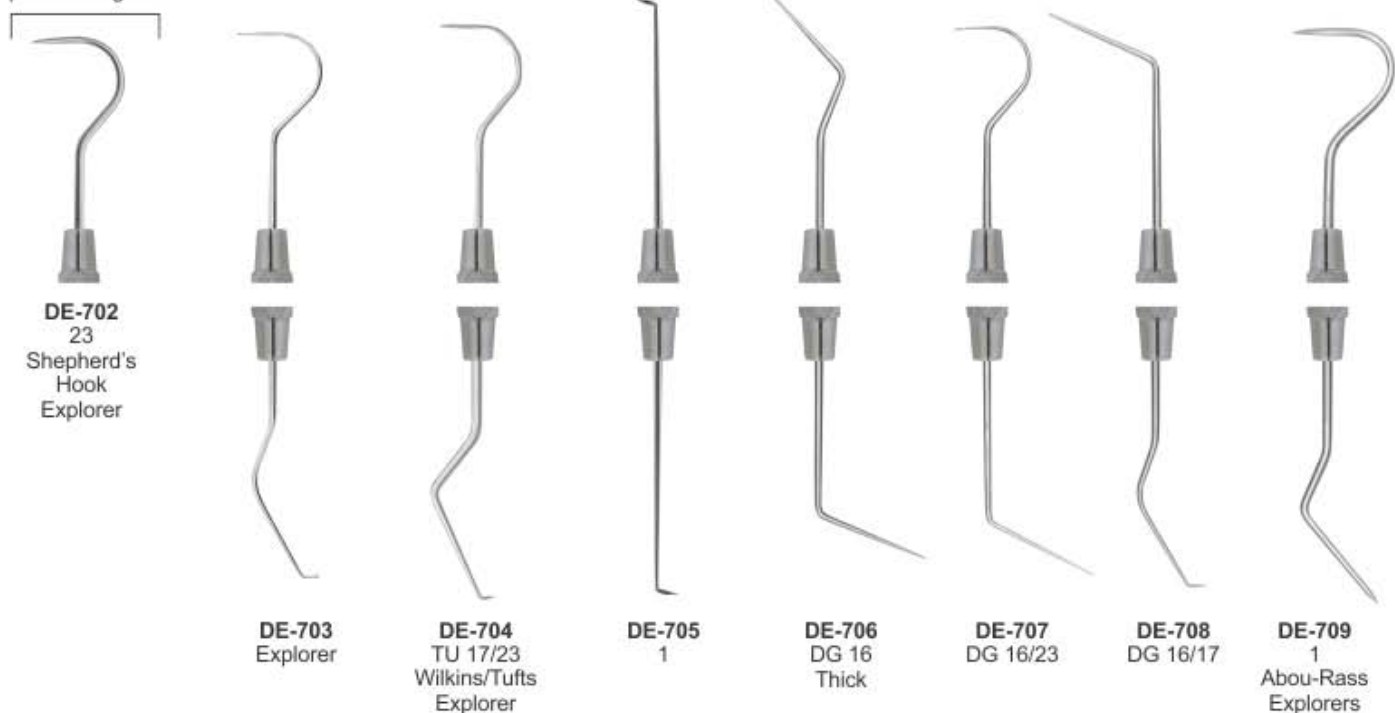

ROOT ELEVATOR

- Элеватор корневой экстракционный
- Elévateurs à racines
- Wurzelheber
- Слеватор корневий екстракційний
- Elevadores para raices
- المصاعد الجذر

FUNCTION: To Loosen Tooth or Root From Bony Socket Prior to Placement of The Extraction Forceps.

Laxutor Root Elevators Set of 9 Pcs



DE-424
2mm Str.



DE-425
3mm Str.



DE-426
5mm Str.



DE-427
3mm Cvd.



DE-428
5mm Cvd.



DE-429
3mm Angle



DE-430
3mm Angle



DE-431
3mm Str.



DE-432
5mm Str.



ROOT ELEVATOR

- Элеватор корневой экстракционный
- Elévateurs à racines
- Wurzelheber
- Слеватор корневий екстракційний
- Elevadores para raices
- المصاعد الجذر

Hylin Roots Elevator



DE-433
Hylin
3mm
Str.

DE-434
Hylin
4mm
Str.

DE-435
Hylin
3.5mm
Left

DE-436
Hylin
3.5mm
Right

Function of Root Elevators: To loosen tooth or root from bony socket prior to placement of the extraction forceps.

Kopp Roots Elevator

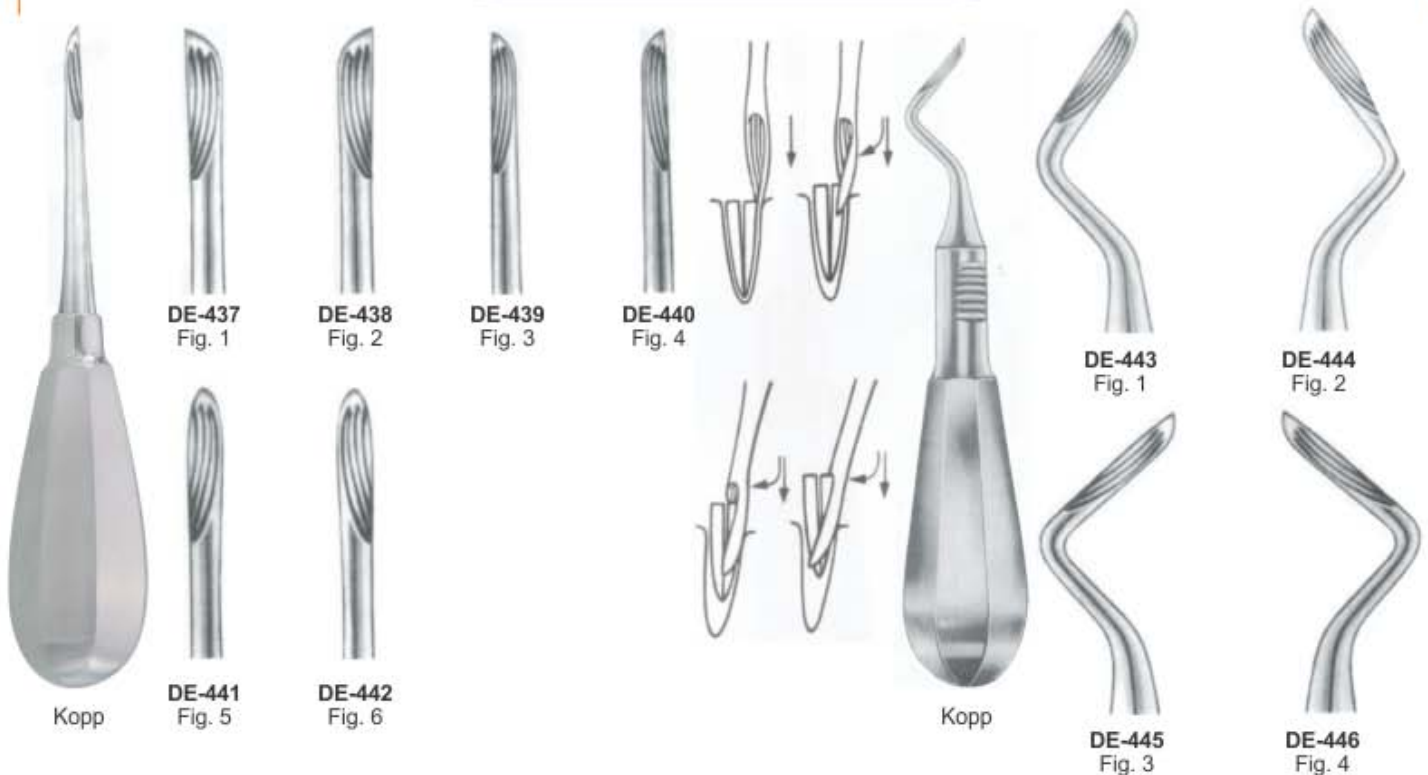

Kopp

DE-441
Fig. 5

DE-442
Fig. 6

Kopp

DE-445
Fig. 3

DE-446
Fig. 4

ROOT ELEVATOR

- Элеватор корневой экстракционный
- Elévateurs à racines
- Wurzelheber
- Єлеватор кореневий екстракційний
- Elevadores para raices
- المصاعد الجذر

Luxier Roots Elevator



DE-447
Luxier
Cvd.

DE-448
Luxier
Str.

Heber Roots Elevator



DE-449
Heber
Bayonet

DE-450
Heber
Bayonet

Bein Roots Elevator



DE-451
Bein,
3mm

DE-452
Bein,
4mm

Function of Root Elevators: To loosen tooth or root from bony socket prior to placement of the extraction forceps.

Bein Roots Elevator



DE-454
2mm
straight
serrated

DE-455
3mm
straight

DE-456
4mm
Curved

DE-458
2mm
straight
serrated

DE-459
3mm
straight

DE-460
4mm
Curved

DE-462
2mm
straight
serrated

DE-463
3mm
straight

DE-464
4mm
Curved

DE-453
Bein
2mm, curved
serrated

DE-457
Bein
2mm, curved
serrated

DE-461
Bein
2mm, curved
serrated

ROOT ELEVATOR

- Элеватор корневой экстракционный
- Elévateurs à racines
- Wurzelheber
- Слеватор корневий екстракційний
- Elevadores para raices
- المصاعد الجذر

W. Barry Roots Elevator



W. Barry
Fig. 1
(125mm)



DE-465
W. Barry
Fig. 1



DE-466
W. Barry
Fig. 2



DE-467
W. Barry
Fig. 3



DE-468
W. Barry
Fig. 4



Function of Root Elevators: To loosen tooth or root from bony socket prior to placement of the extraction forceps.



Winter
Fig. 1L
125mm

DE-469
Winter
Fig. 1L



DE-470
Winter
Fig. 1R



DE-471
775/3
Winter
11 L



DE-472
775/4
Winter
11 R



DE-473
775/5
Winter
12 L



DE-474
775/6
Winter
12 R



DE-475
775/7
Winter
13 L



DE-476
775/8
Winter
13 R



DE-477
Winter
Fig. 1L



DE-478
Winter
Fig. 1R



DE-479
Lecluse
bayonet



DE-480
Potts "T-Handle"
Elevator-Left



DE-481
Potts "T-Handle"
Elevator-Right

ROOT ELEVATOR

- Элеватор корневой экстракционный
- Elévateurs à racines
- Wurzelheber
- Слеватор корневий екстракційний
- Elevadores para raices
- المصاعد الجذر



DE-482
Fig. 1
Chompret



DE-483
Fig. 2
Chompret



DE-484
Fig. 3
Chompret



DE-485
Fig. 4
Chompret



Lecluse elevator for lower third molar dislocation



Chompret syndesmotome, sickle pattern



DE-486



DE-487



DE-488



DE-489



DE-490



DE-491



DE-492

Root Pick Elevator With Gold Flexible Points

ROOT ELEVATOR

- Элеватор корневой экстракционный
 - Elévateurs à racines
 - Wurzelheber
- Слеватор корневий экстракційний
 - Elevadores para raices
 - المصاعد الجذر

Heidbrink Roots Elevator



DE-493
Heidbrink
Straight

DE-494
Heidbrink
Left

DE-495
Heidbrink
Right

DE-496
Heidbrink
Straight

DE-497
Heidbrink
Left

DE-498
Heidbrink
Right

Syndesmotomes Roots Elevator



DE-499
Straight

DE-500
Left

DE-501
Right

Periotome Roots Elevator

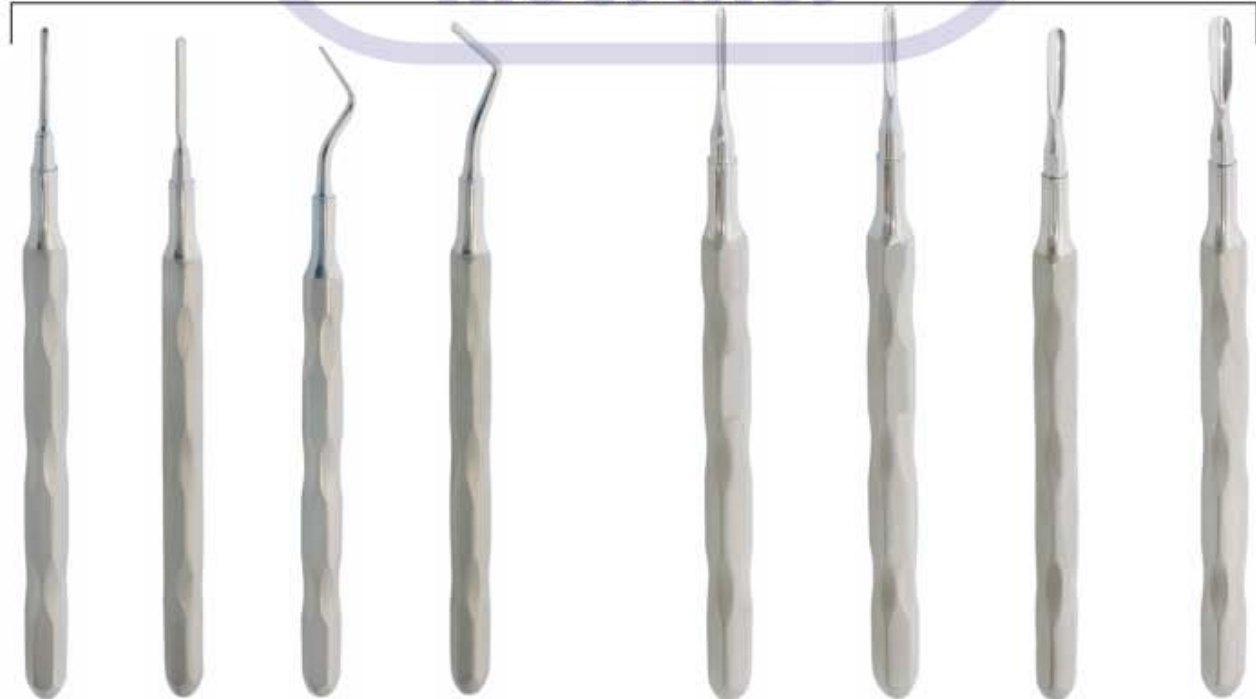

DE-502
Periotome
2.1mm
Straight

DE-503
Periotome
2.6mm
Straight

DE-504
Periotome
2.1mm
Angular

DE-505
Periotome
2mm
Curved

DE-506
Periotome
2.0mm

DE-507
Periotome
2.5mm

DE-508
Periotome
3.0mm

DE-509
Periotome
4.0mm

Syndesmotomes

ROOT ELEVATOR

- Элеватор корневой экстракционный
- Elévateurs à racines
- Wurzelheber
- Слеватор корневий экстракційний
- Elevadores para raices
- المصاعد الجذر

FUNCTION: To loosen small root fragments from bony socket

Heidbrink Roots Elevator

Warwick-James

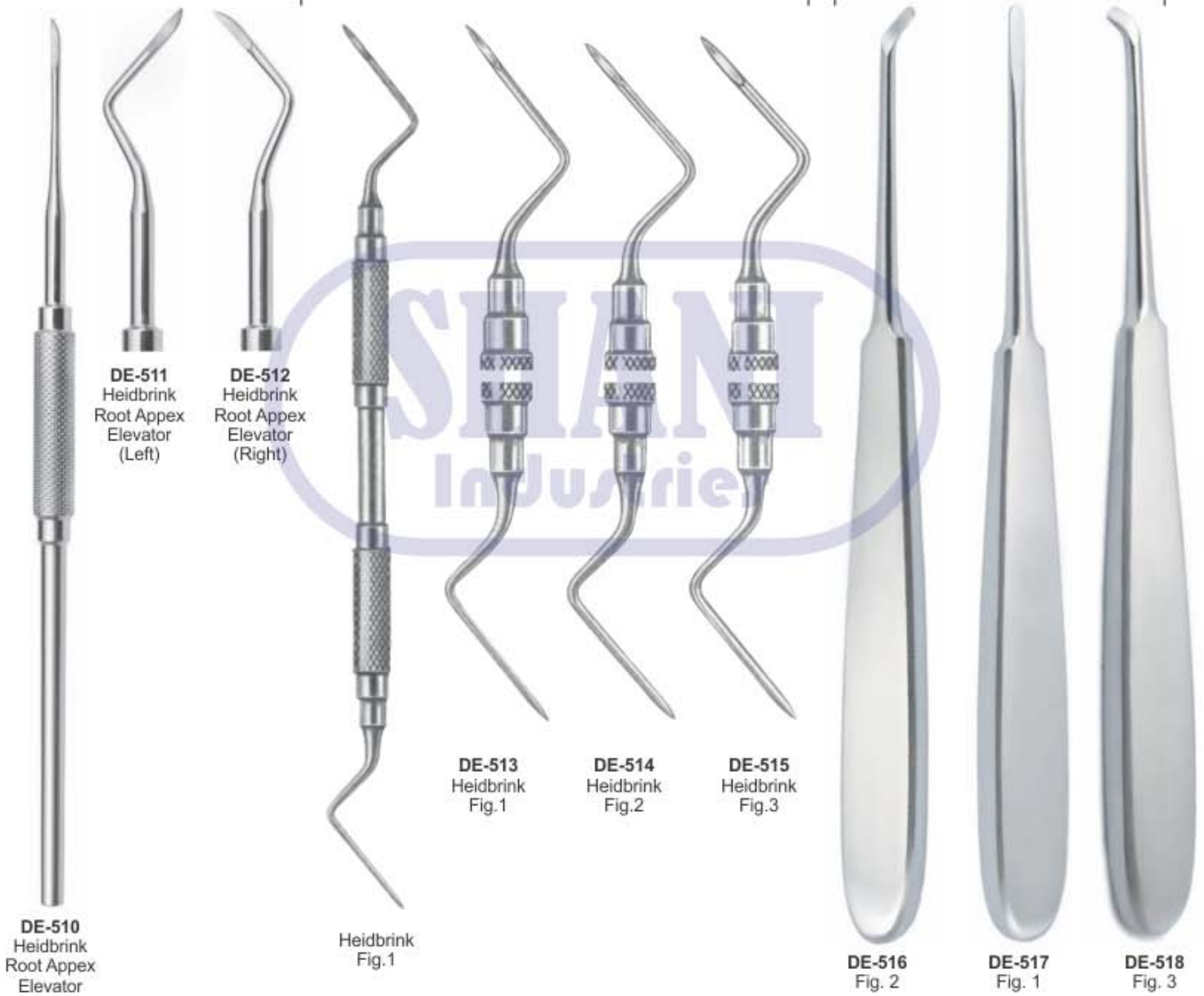

DE-511
Heidbrink
Root Apex
Elevator
(Left)

DE-512
Heidbrink
Root Apex
Elevator
(Right)

DE-513
Heidbrink
Fig.1

DE-514
Heidbrink
Fig.2

DE-515
Heidbrink
Fig.3

Heidbrink
Fig.1

DE-510
Heidbrink
Root Apex
Elevator

DE-516
Fig. 2

DE-517
Fig. 1

DE-518
Fig. 3

ROOT ELEVATOR

- Элеватор корневой экстракционный
- Elévateurs à racines
- Wurzelheber
- Слеватор корневий екстракційний
- Elevadores para raices
- المصاعد الجذر



DE-519
1S
(Straight 1mm)



DE-520
2S
(Straight 2mm)



DE-521
3S
(Straight 3mm)



DE-522
5S
(Straight 5mm)



DE-523
3C
(Curved 3mm)



DE-524
5C
(Curved 5mm)



DE-525
3CA
(Curved Angle 3mm)



DE-526
3IC
(Inverted Curved 3mm)



DE-527
DE 3
(Dual Edge 3mm / 1.5mm)



DE-528
DE 5
(Dual Edge 5mm / 3mm)

ROOT ELEVATOR

- Элеватор корневой экстракционный
- Elévateurs à racines
- Wurzelheber
- Єлеватор кореневий екстракційний
- Elevadores para raices
- المصاعد الجذر



DE-529
Luxators Set of 7 Pcs

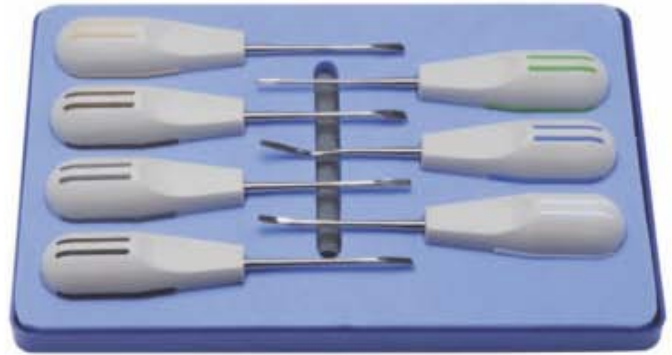

DE-530
Luxators Set of 7 Pcs



DE-531
Luxators Set of 8 Pcs



DE-532
Root Elevators Set of 10 Pcs



DE-533
Elevators Set of 8 Pcs



DE-534
Elevators Set of 8 Pcs

ROOT ELEVATOR

- Элеватор корневой экстракционный
- Elevator corneviu extracționii
- Elévateurs à racines
- Elevadores para raíces
- Wurzelheber
- المصاعد الجذر

PDL ELEVATORS

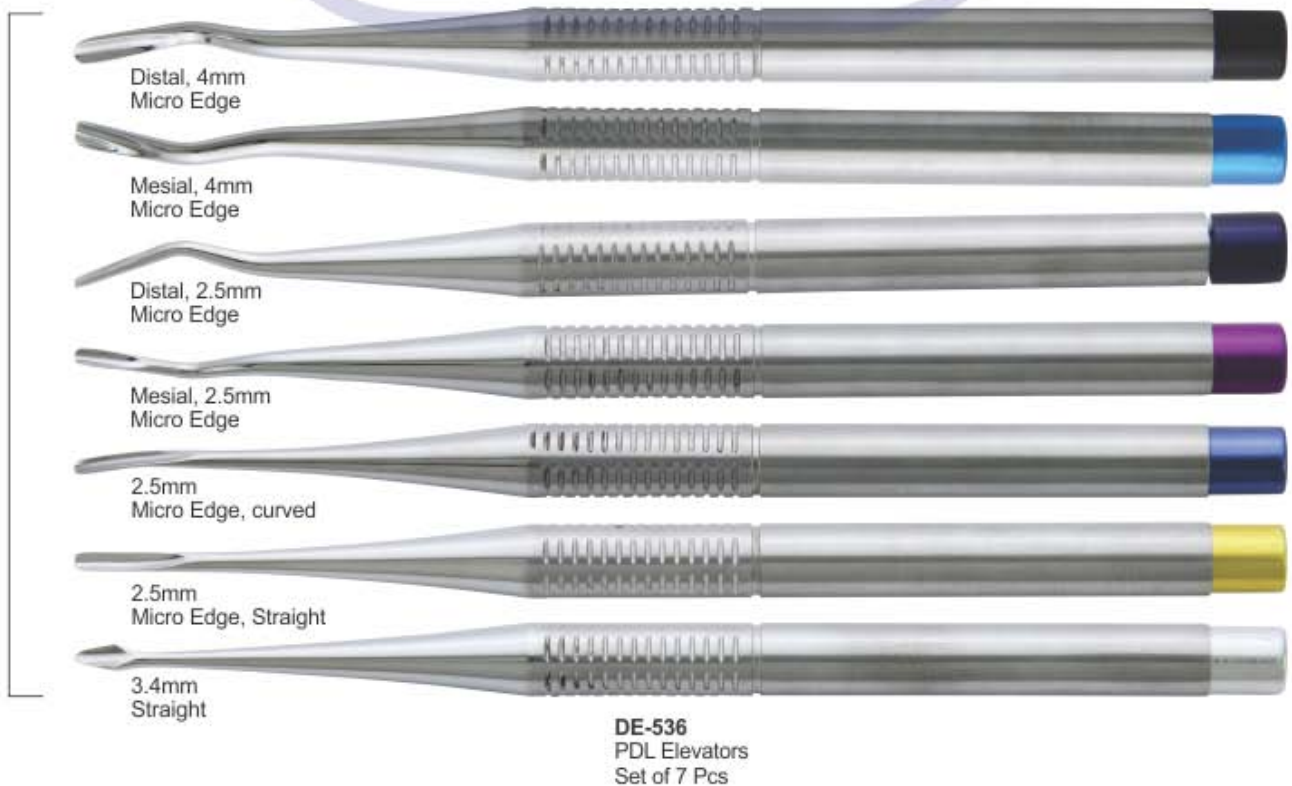

Our Scalers

Compare our scalers and curettes with the best in the industry and you will immediately recognize we are equal in every way but one... price. Note the deep precision knurling for better tactile feel. The same high-grade stainless steel tips, the same light weight (under 18 grams) for less hand fatigue, the same professional craftsmanship, and surpassing the highest industry standards. Of course, any manufacturer can make these claims, but we guarantee and certify ours.

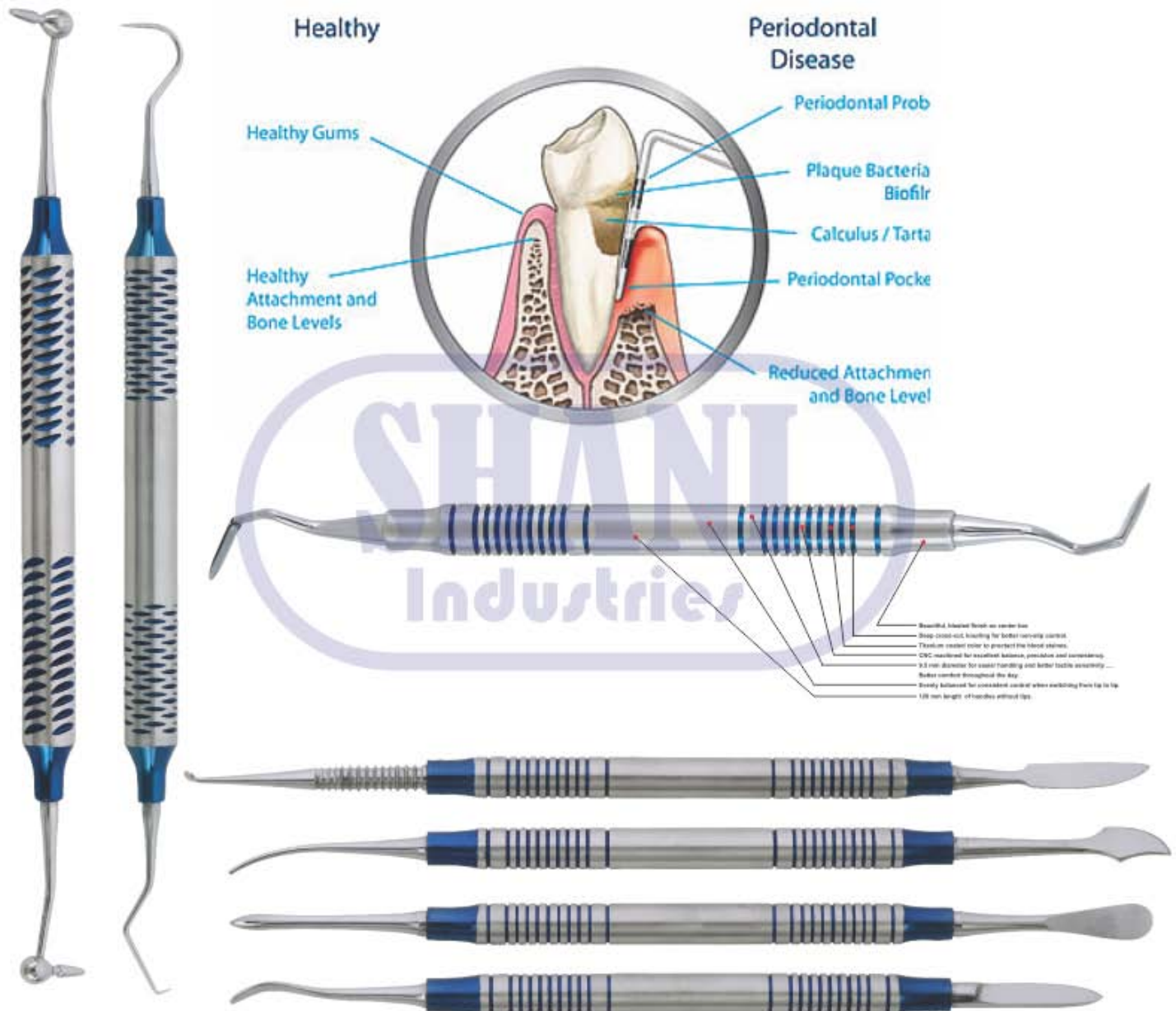

- High-polish mirror finish tips.
- Manufactured within the guidelines of the FDA quality assurance system for good manufacturing practices.
- Highest grade German stainless steel, razor sharp, durable tips. Rockwell hardened to 60 RHc.
- 27 of the most popular designs from graceys to McCalls to columbias, and many european patterns.
- All instruments are guaranteed against defects in material and workmanship.

- All instruments bear the ce mark, emblematic of the european community's highest standards.
- Customer satisfaction guarantee, too!
- Less than 20 grams ... Lightweight for less hand fatigue.
- Manufactured to the most exacting standards so the 50th instrument you buy is exactly like your first.
- You decide ... Why pay more for the same high-quality instruments?

VALUED BUYERS

Compare our scalers and curettes with the best in the industry and you will immediately recognize we are equal in every way but one... price. Note the deep precision knurling for better tactile feel. The same high-grade stainless steel tips, the same light weight (under 20 grams) for less hand fatigue, the same professional craftsmanship, and surpassing the highest industry standards. Of course, any manufacturer can make these claims, but we guarantee and certify ours. We regularly manufacturing below articles in showing handles & pattern A to L for better grip & perfection. We are also fully equipped & capable to develop these instruments as per your own specific requirements & demands in materials, sizes, shapes and patterns.



A-Hollow Handle Ø 10 mm



B-Hollow Handle Ø 10 mm



C-Hollow Handle Ø 10 mm



D-Hollow Handle Ø 10 mm



E-Hollow Handle Ø 10 mm



F-Hollow Handle Ø 10 mm



G-Hollow Handle Ø 10 mm



H-Hollow Handle Ø 6.4 mm



I-Hollow Handle Ø 8 mm



J-Hollow Handle Ø 10 mm



K-Soild Handle Ø 6 mm



L-Soild Handle Ø 6 mm

MOUTH MIRRORS

- зеркала
- Espejos de la boca
- Mundspiegel
- дзеркала
- Miroirs à la bouche
- مرايا الفم

Plain



DE-600 Fig. 3 Ø20mm
DE-601 Fig. 4 Ø22mm
DE-602 Fig. 5 Ø24mm
DE-603 Fig. 6 Ø26mm



Cone-Socket Plain



DE-604 Fig. 3 Ø20mm
DE-605 Fig. 4 Ø22mm
DE-606 Fig. 5 Ø24mm

Magnifying



DE-607 Fig. 3 Ø20 mm
DE-608 Fig. 4 Ø22 mm
DE-609 Fig. 5 Ø24 mm



Cone-Socket Magnifying



DE-610 Fig. 3 Ø20mm
DE-611 Fig. 4 Ø22mm
DE-612 Fig. 5 Ø24mm

Rhodium



DE-613 Fig. 3 Ø20mm
DE-614 Fig. 4 Ø22mm
DE-615 Fig. 5 Ø24 mm



Cone-Socket Rhodium



DE-616 Fig. 3 Ø20mm
DE-617 Fig. 4 Ø22mm
DE-618 Fig. 5 Ø24mm

Front Surface



DE-619 Fig. 3 Ø20mm
DE-620 Fig. 4 Ø22mm
DE-621 Fig. 5 Ø24mm
DE-622 Fig. 6 Ø26mm



Cone-Socket Front Surface



DE-623 Fig. 3 Ø20mm
DE-624 Fig. 4 Ø22mm
DE-625 Fig. 5 Ø24mm

HANDLES FOR MOUTH MIRRORS

- Ручки для зеркал
- Manches pour miroirs à bouche
- Mundspiegelgriffe
- Ручки для дзеркал
- Mangos para espejos de boca
- مقابض لمرآيا الفم



DE-626
Hollow Mirror
Handle Round
Ø 10 mm



DE-627
Hollow Mirror
Hexagonal
Handle
Ø 8 mm



DE-628
Hollow
Ø 8 mm



DE-629
Hollow Mirror
Hexagonal
Handle
Ø 10 mm



DE-630
Hollow Mirror
Handle
Ø 8 mm



DE-631
Hollow Mirror
Handle
Ø 10 mm



DE-632
Mirror Handle
Solid
Ø 6 mm



DE-633
Mirror Handle
Solid
Ø 6 mm



DE-634
Mirror Handle
Solid Octagonal
Ø 6 mm



DE-635
Mirror Handle
Stem
with Rule
35mm



DE-636
Mirror Handle
Solid
Stem with
Rule 35mm



DE-637
Cone-Socket
Solid Octagonal
Ø 6 mm



DE-638
Cone-socket
Solid
Ø 6 mm



DE-639
Cone-socket
Hexagonal
Handle
Ø 6 mm

Cone-Socket Mirror Handle

EXPLORERS

- Зонды
- Sondes
- Zahnsonden
- Зонди
- Sondas
- المستكشفين

Examination kit Set of 3 Pieces



DE-640
Probe

DE-641
Mirror

DE-642
College Forcep
15cm



Examination Set of 4 Pieces



DE-643
Exp,23/17-A

DE-644
Exavators

DE-645
Tweezers

DE-646
Mouth Mirror

DE-647

First Aid Examination Set of 3 Pieces



DE-648

First Aid Examination Set of 3 Pieces



DE-649

First Aid Examination Set of 3 Pieces



DE-650

First Aid Examination Set of 3 Pieces



TWEEZERS

- Пинцеты
 - Précelles - Brucelles
 - Zahnpinzetten
- Пинцети
 - Pinzas para algodón
 - ملاقط



DE-651
Surgical
11.5cm



DE-652
London College
15cm



DE-653
Semken Taylor
Str.



DE-654
Semken Taylor
Cvd.



DE-655
Meriam
16cm



DE-656
Dressing
14cm



DE-657
Semken Taylor
1x2 Straight



DE-658
Semken Taylor
1x2 Curved



DE-659
Gilles
15cm 1x2



DE-660
14cm 1x2



DE-661
Perry
13cm



DE-662
Atraumatic
15cm Cvd



DE-663
Atraumatic
15cm Str.



DE-664
College with Lock
15cm Cvd.



DE-665
Gerald
17.5cm



DE-666
with lock
15cm



DE-667
Atraumatic
17.5cm

TWEEZERS

- Пинцеты
- Précelles - Brucelles
- Zahnpinzetten

- Пинцети
- Pinzas para algodón
- ملاقط



DE-668
Adson-TC
12cm



DE-669
Adson-TC
12cm 1x2



DE-670
Adson-TC
15cm 1x2



DE-671
Adson
12cm



DE-672
Adson
12cm 1x2



DE-673
Adson
15cm 1x2



DE-674
Adson Brown
12cm



DE-675
Crane Kaplan
15cm



DE-676
Crane Kaplan
15cm



DE-677
Crane Kaplan
15cm



DE-678
Hemingway
15cm



DE-679
Miller
15cm Str.



DE-680
Miller
15cm Cvd.



DE-681
Dressing
Tweezer
14.5cm



DE-682
College
Curved
Tip
15cm



DE-683
Maryam
Tweezers
15cm



DE-684
College
Tweezer
15cm



DE-685
Perry
Tweezer
12.5cm



DE-686
Self-locking
Tweezer
15cm

FILLING INSTRUMENTS

- Инструменты для реставрации
- Instruments pour plombage
- Füllungsinstrumente (mit Kontrawinkel)
- Инструменти для реставрації
- Instrumentos para obturaciones
- ملء الصكوك

FILLING INSTRUMENTS (Gold Pointed) SOLID HANDLE 6MM, LENGTH 170MM



EXPLORERS

- Зонды
- Sondes
- Zahnsonden
- Зонди
- Sondas
- المستكشفين

Probes Double Ended 6mm, length 170mm



DE-710
Williams

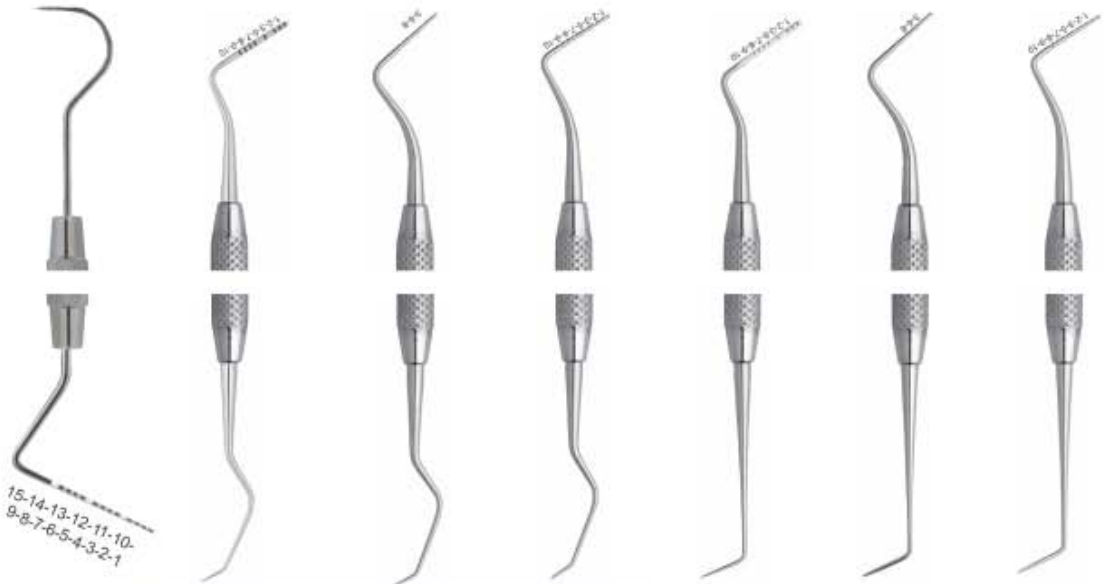

DE-711
23/UNC1
university of north
carolina Explorer

DE-712
Goldman Fox
Fig.17

DE-713
University
of Michigan
Fig.17

DE-714
Williams
Fig.17

DE-715
Goldman Fox
Fig.16

DE-716
University
of Michigan
Fig.16

DE-717
Williams
Fig.16

Pointed Probes Double Ended Handle 6mm, length 170mm

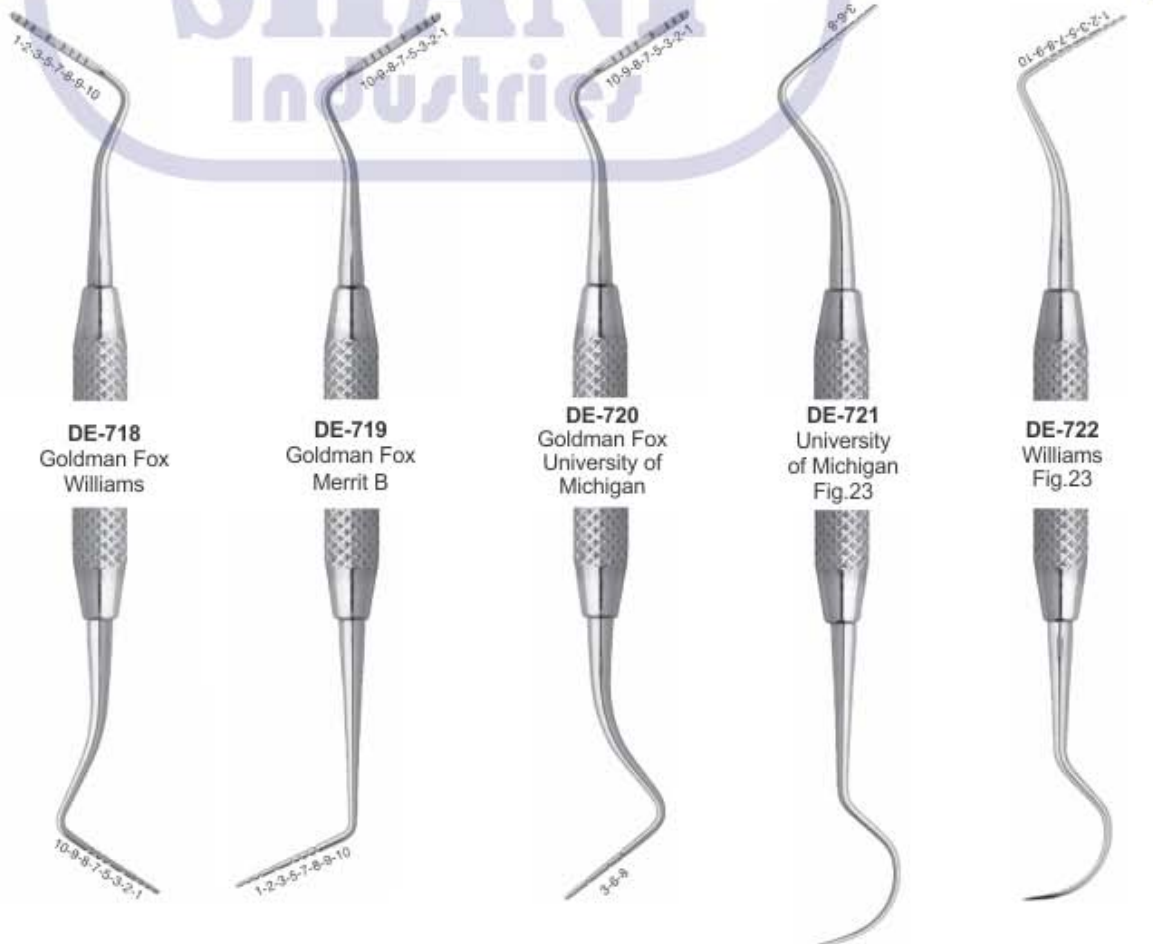

DE-718
Goldman Fox
Williams

DE-719
Goldman Fox
Merrit B

DE-720
Goldman Fox
University of
Michigan

DE-721
University
of Michigan
Fig.23

DE-722
Williams
Fig.23

EXPLORERS

- Зонды
- Sondes
- Zahnsonden
- Зонди
- Sondas
- المستكشفين

EXPLORERS INSTRUMENTS SOLID HANDLE 6MM, LENGTH 170MM

PLUGGERS

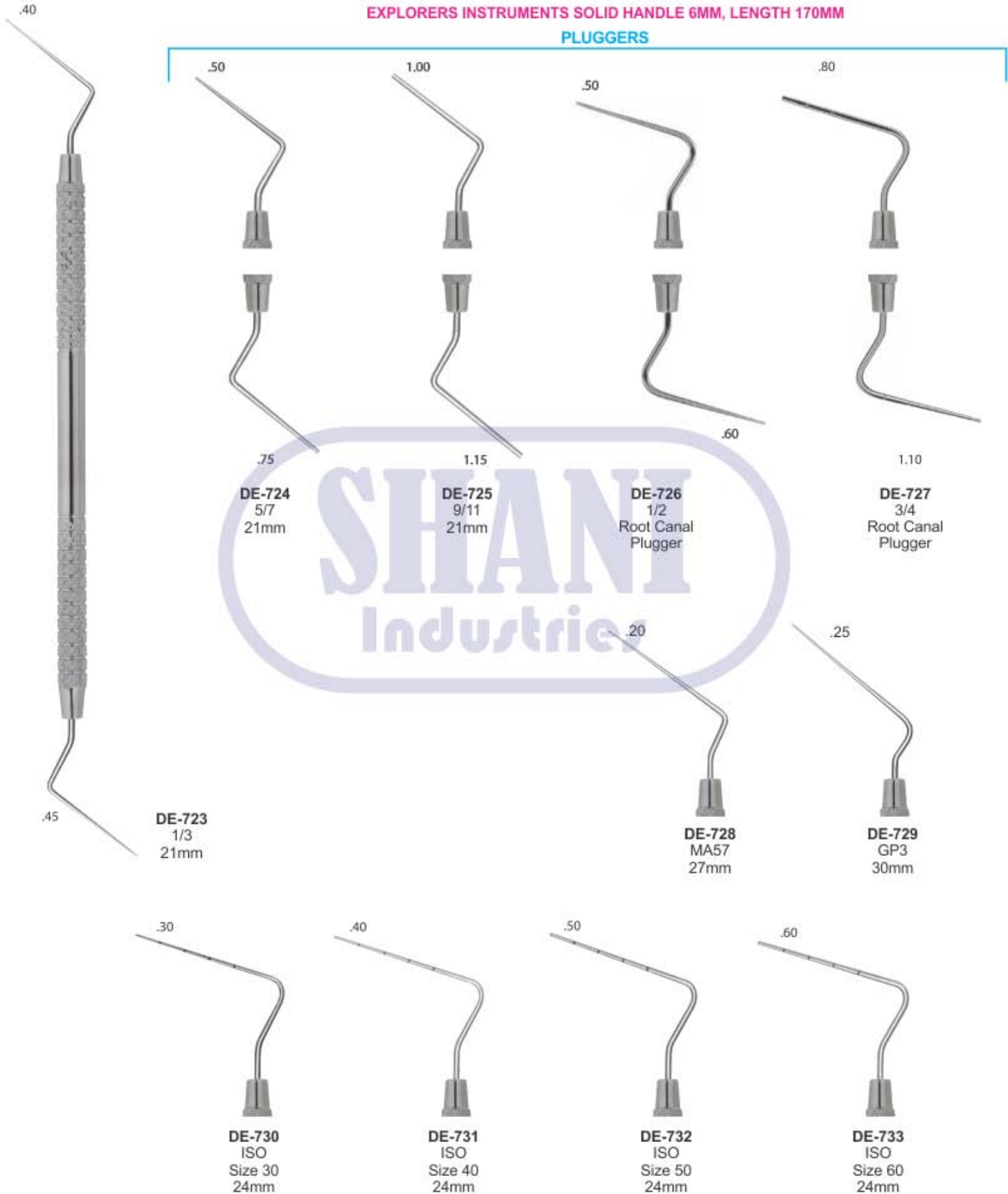

PERIODONTAL PROBES

- Зонды пародонтологические
 - Sondes paradontales
 - sonda paradontali
- зонди пародонтологічні
 - Sondas paradontales
 - المسابر اللثة

SPREADERS

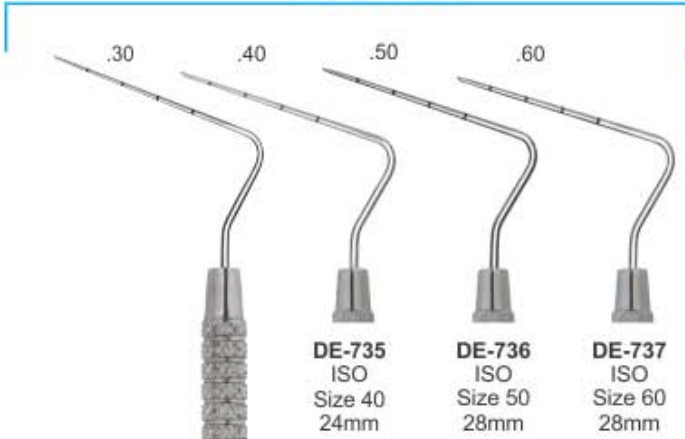

DE-735
ISO
Size 40
24mm

DE-736
ISO
Size 50
28mm

DE-737
ISO
Size 60
28mm

HEAT CARRIERS

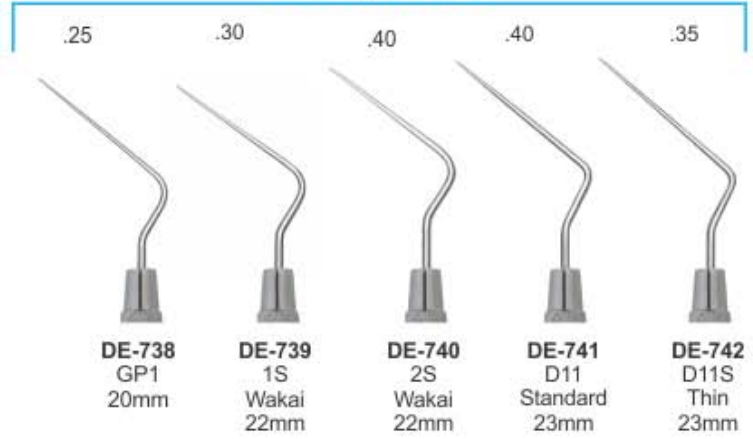

DE-738
GP1
20mm

DE-739
1S
Wakai
22mm

DE-740
2S
Wakai
22mm

DE-741
D11
Standard
23mm

DE-742
D11S
Thin
23mm



HEAT CARRIERS

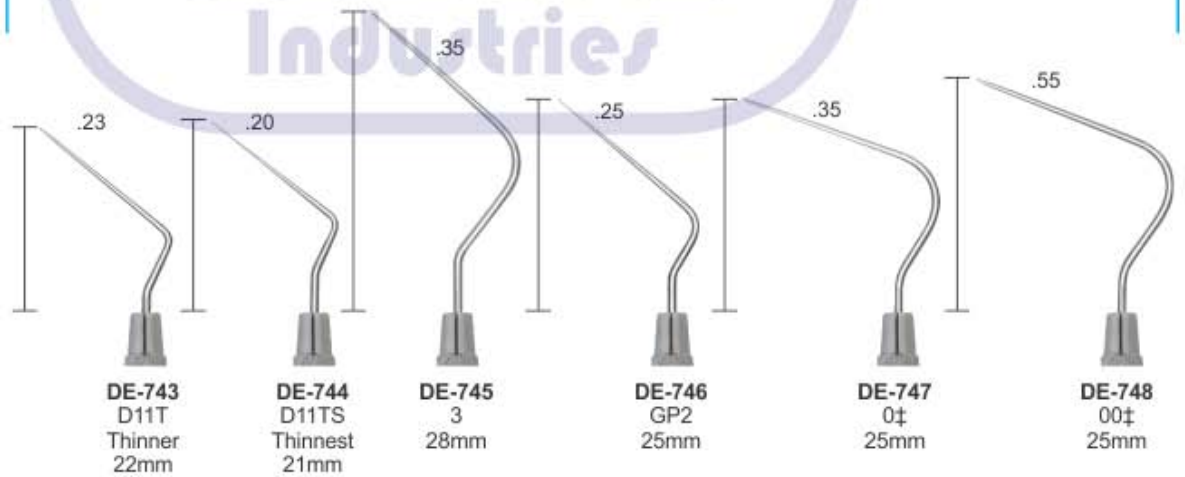

DE-743
D11T
Thinner
22mm

DE-744
D11TS
Thinnest
21mm

DE-745
3
28mm

DE-746
GP2
25mm

DE-747
0±
25mm

DE-748
00±
25mm

DE-734
ISO
Size 30
24mm

PERIODONTAL PROBES

- Зонды пародонтологические
- Sondes paradontales
- sonda parodontali
- зонди пародонтологічні
- Sondas paradontales
- المسابر اللثة

ENDODONTICS INSTRUMENTS

ANTERIOR



DE-749
8A
29mm

DE-750
8 1/2A
29mm

DE-751
9A
29mm

DE-752
9 1/2A
29mm

DE-753
10A
29mm

DE-754
10 1/2A
29mm

DE-755
11A
29mm

DE-756
11 1/2A
29mm

DE-757
12A
29mm

LUKS



DE-758
L1
18mm

DE-759
L2
18mm

DE-760
L3
18mm

DE-761
L4
18mm



DE-762
Gracey Curettes 1/2



DE-763
Gracey Curettes 3/4



DE-764
Gracey Curettes 5/6



DE-765
Gracey Curettes 7/8



DE-766
Gracey Curettes 9/10



DE-767
Gracey Curettes 11/12



DE-768
Gracey Curettes 13/14



DE-769
Gracey Curettes 1/2



DE-770
Gracey Curettes 3/4



DE-771
Gracey Curettes 5/6



DE-772
Gracey Curettes 7/8



DE-773
Gracey Curettes 9/10



DE-774
Gracey Curettes 11/12



DE-775
Gracey Curettes 13/14



ROOT ELEVATOR

- Элеватор корневой экстракционный
- Elévateurs à racines
- Wurzelheber
- Єлеватор кореневий екстракційний
- Elevadores para raices
- المصاعد الجذر

PDL ELEVATORS

Delicate Arrow tip



4,0mm straight
4,0mm curved

Luxivators straight
atraumatic luxation of the tooth



2,5mm straight
3,5mm straight
4,5mm straight

Luxivators curved
atraumatic luxation of the tooth



2,5mm curved
3,5mm curved
4,5mm curved



DE-537
PDL Elevators
Set of 8 Pcs



GRACEY MINI FIVE

Hollow Handle 9.5mm, Length 170mm Ceramic Coated Handle



DE-777
Fig. 3/4 Gracey 3M



DE-778
Fig. 5/6 Gracey 3M



DE-779
Fig. 7/8 Gracey 3M
Buccal and lingual/
Palatal surfaces



DE-780
Fig. 11/12 Gracey 3M
Mesial



DE-781
Fig. 13/14 Gracey 3M
Distal

DE-776
Fig. 1/2
Gracey 3m



GRACEY AFTER FIVE

Hollow Handle 9.5mm, Length 170mm Ceramic Coated Handle



DE-783
Gracey 3/4 AF



DE-784
Gracey 5/6 AF



DE-785
Gracey 7/8 AF



DE-786
Gracey 11/12 AF



DE-787
Gracey 13/14 AF

DE-782
Gracey
1/2 AF



Gracey Curettes



$\frac{3...1}{3...1} \mid \frac{1...3}{1...3}$ **DE-788** Fig. 1/2 GR - Gracey
Buccal surfaces



$\frac{5...1}{5...1} \mid \frac{1...5}{1...5}$ **DE-789** Fig. 3/4 GR - Gracey
Lingual/Palatal surfaces



$\frac{5...1}{5...1} \mid \frac{1...5}{1...5}$ **DE-790** Fig. 5/6 GR - Gracey



$\frac{8...4}{8...4} \mid \frac{4...8}{4...8}$ **DE-791** Fig. 7/8 GR - Gracey
Buccal and lingual/
palatal surfaces



$\frac{8...4}{8...4} \mid \frac{4...8}{4...8}$ **DE-792** Fig. 9/10 GR - Gracey
Buccal and lingual/
palatal surfaces more angled



$\frac{8...4}{8...4} \mid \frac{4...8}{4...8}$ **DE-793** Fig. 11/12 GR - Gracey
Mesial



$\frac{8...4}{8...4} \mid \frac{4...8}{4...8}$ **DE-794** Fig. 13/14 GR - Gracey
Distal



$\frac{8...4}{8...4} \mid \frac{4...8}{4...8}$ **DE-795** Fig. 15/16 GR - Gracey
Mesial



$\frac{8...4}{8...4} \mid \frac{4...8}{4...8}$ **DE-796** Fig. 17/18 GR - Gracey
Distal

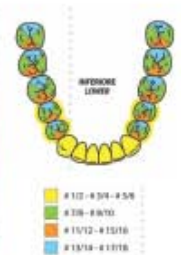
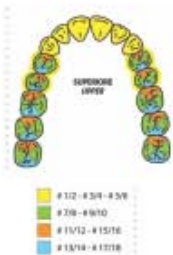

Sickle Scalars



DE-797 Fig. U15/33 - Towner-Jaquette



DE-798 Fig. U15/30 - Towner-Jaquette



DE-799 Fig. H5/33



DE-800 Fig. H6/H7



DE-801 Fig. 30/33 - Jaquette



DE-802 Fig. T2/T3 - Taylor



DE-803 Fig. 204



DE-804 Fig. 204S



DE-805 Fig. 11/12 - MC - McCall
Mesial



DE-806 Fig. 13/14 - MC - McCall
Distal



Straight and curved sickle scalars
Feature: 2 cutting edges curved facial component lipped ends

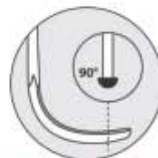

Universal curettes
are characterized by an angle of 90° between the terminal stem and the cutting component.

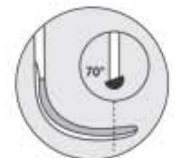

Gracey curettes
are characterized by an angle of 70° between the terminal stem and the cutting component.

Universal Curettes



DE-807 Fig. 13S/14S - MC - McCall



DE-808 Fig. 17S/18S - MC - McCall
Distal



DE-809 Fig. M23



DE-810 Fig. 204SD



DE-811 Fig. YG7/8-Younger Good



DE-812 Fig. L 1/2 - Langer



DE-813 Fig. L 3/4 - Langer



DE-814 Fig. L 5/6 - Langer



DE-815 Fig. M 23A



DE-816 Fig. M 23B

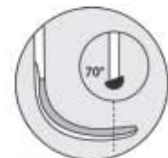
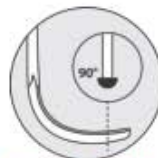
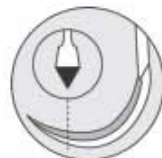
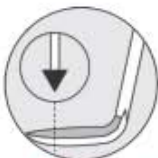

Straight and curved sickle scalers
Feature: 2 cutting edges curved facial component tipped ends

Universal curettes
are characterized by an angle of 90° between the terminal stem and the cutting component.

Gracey curettes
are characterized by an angle of 70° between the terminal stem and the cutting component.

Periodontal knives





DE-825
17



DE-826
17D



DE-827
54A
Mühlemann



DE-828
67



DE-829
37D

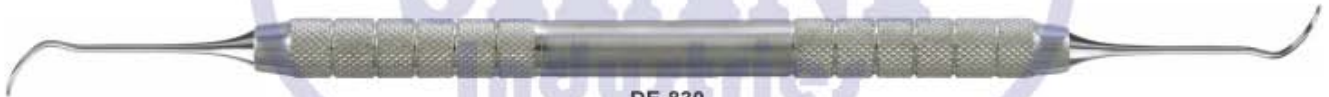

DE-830
8
Wiland



DE-831
8
Holz

0.9 MM



DE-832
9
Holz

0.7 MM

Chisels
Diamond coated margin trimmers

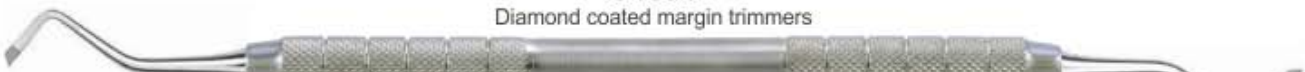

DE-833
40P



DE-834
40A

Thanks to the diamond-coated hand instruments the margins are evenly levelled.

Margin trimmers



DE-835
1TH2 Hirt



DE-836
5TH6 Hirt



DE-837
3TH4 Hirt



DE-838
7TH8 Hirt



DE-839
62NS61

2.0 MM

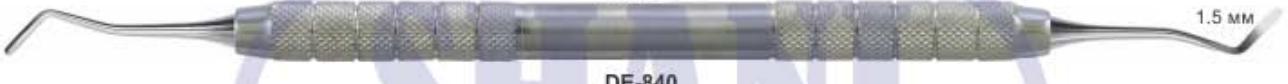

DE-840
37NS36

1.5 MM

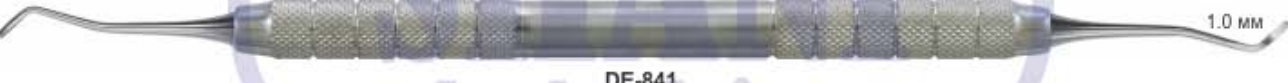

DE-841
66NS65

1.0 MM

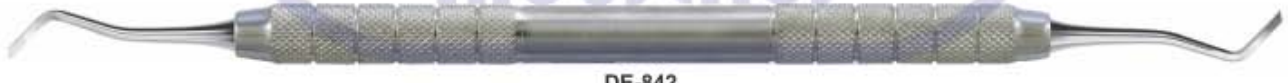

DE-842
79CI80 Black



DE-843
77CI78 Black



DE-844
279CI280 Black



DE-845
277CI278 Black



DE-846
179CI180 Black



DE-847
177CI178 Black

CHISELS



DE-848
1/2 Werdelstaedt



DE-849
3/4 Werdelstaedt



DE-850
7 Straight



DE-851
5/6 Straight



DE-852
7/10 Straight



DE-853
8/9 Binangle



DE-854
11/12 Binangle



DE-855
40/41 Binangle

Tartar Remover Instruments Solid Handle Ø 6 mm



DE-856
Fig. 1



DE-857
Fig. 1L
Left



DE-858
Fig. 1R
Right



DE-859
Fig. 2L
left



DE-860
Fig. 2R
Right



DE-861



DE-862



DE-863





DE-887



DE-888



DE-889



DE-890



DE-891



DE-892



DE-893



DE-894



Ball Burnishers



Hatches



Spatulas rounded and sharp

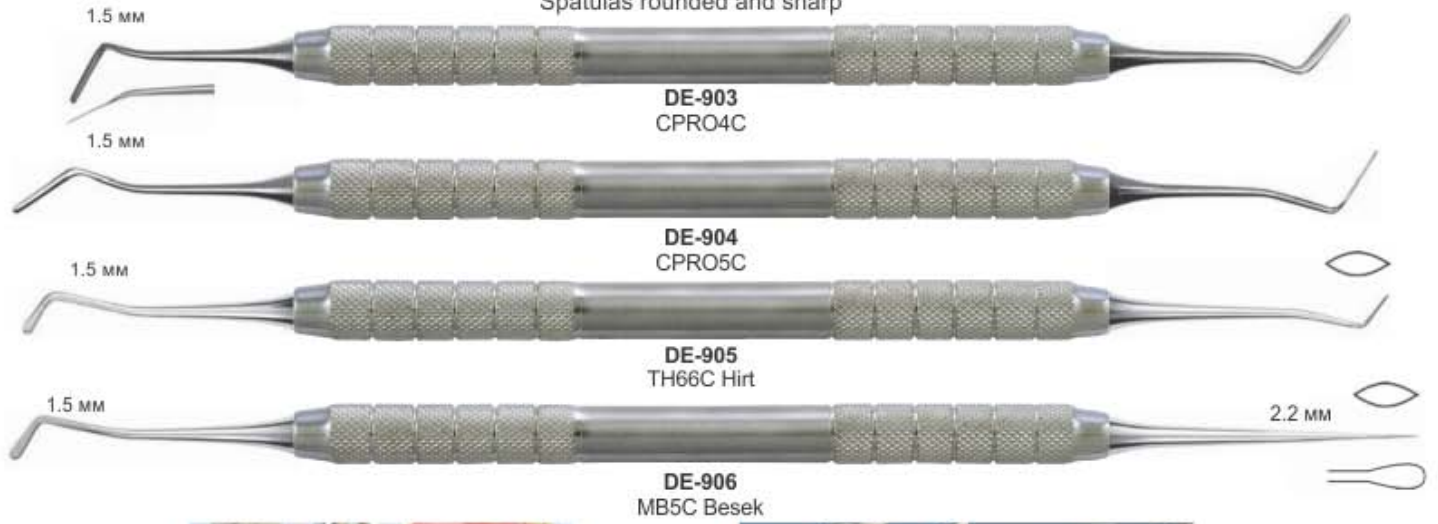

Spatulas Blade Thickness 0.22 mm



Spatulas

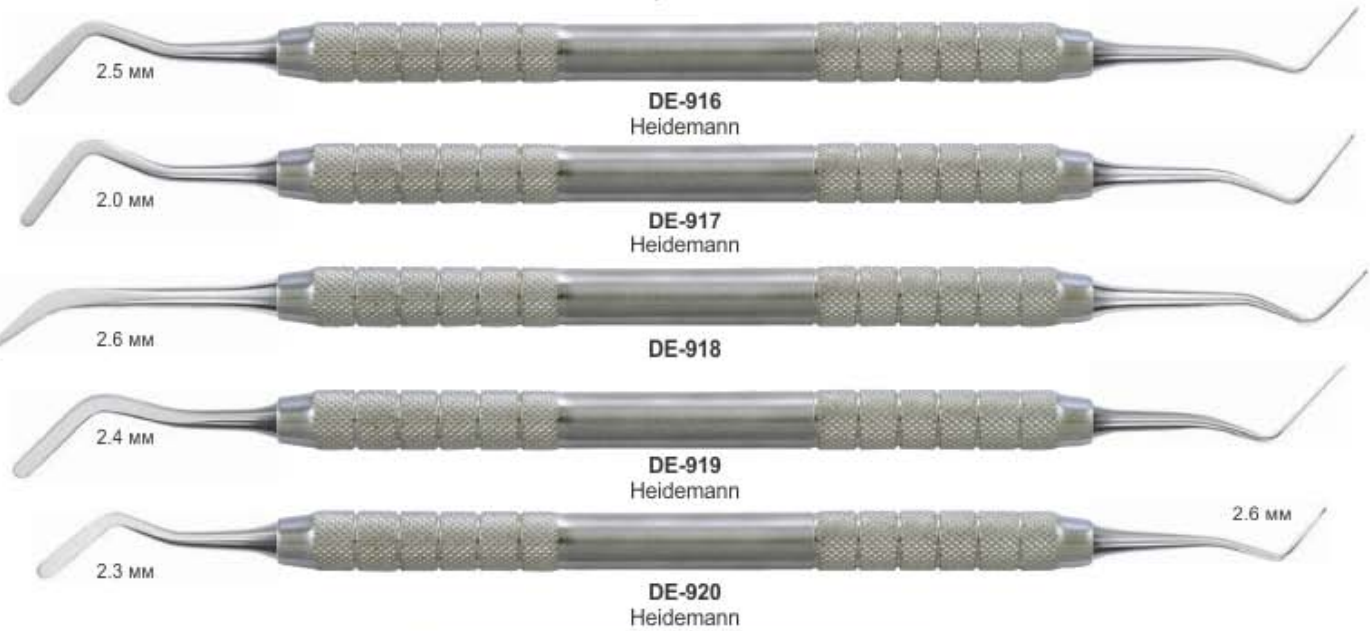

Spatulas-Pluggers

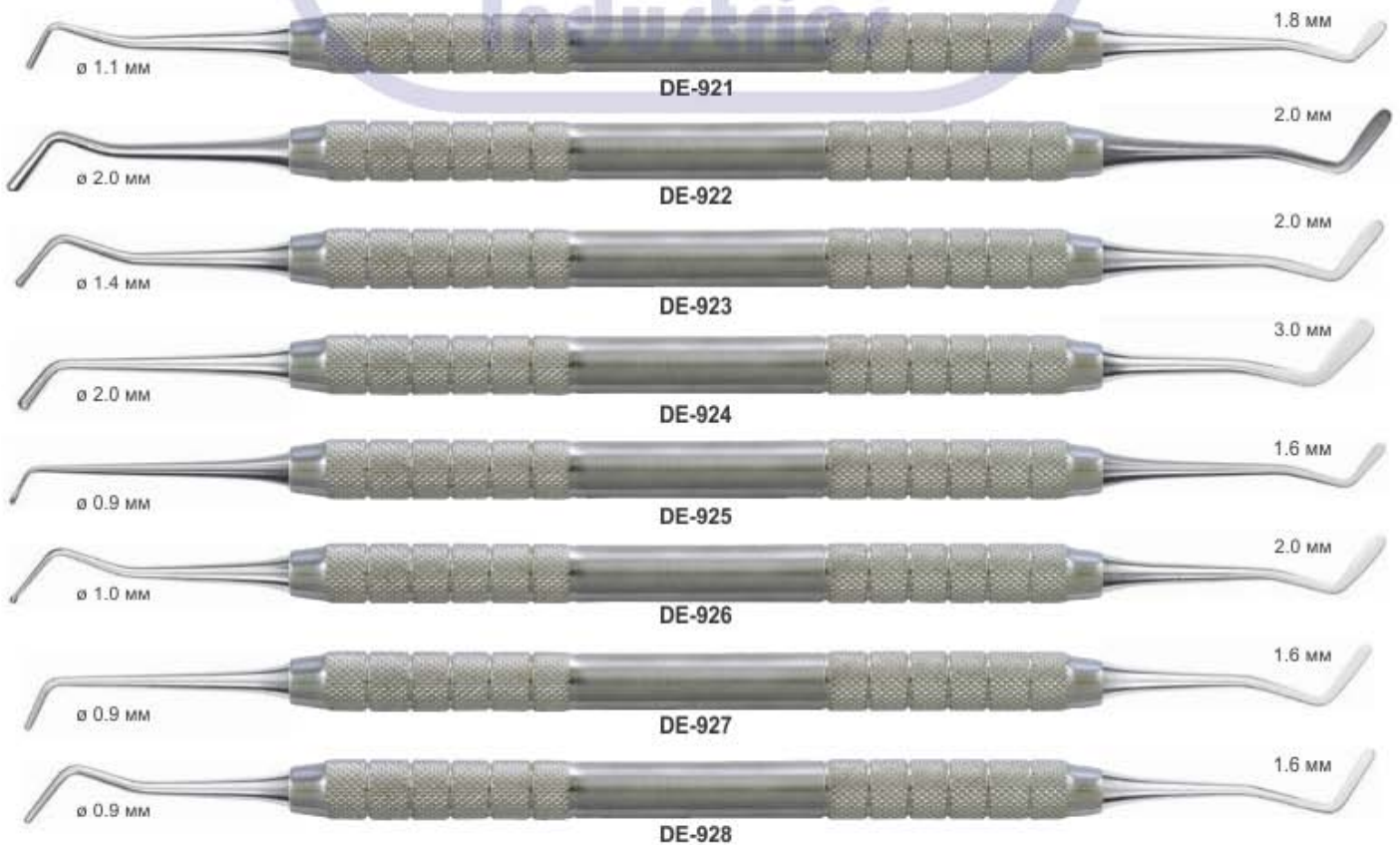

Water drop Our excavators have particularly sharp blades, free of burrs and perfectly rounded.



DE-929
0.8 MM



DE-930
0.8 MM

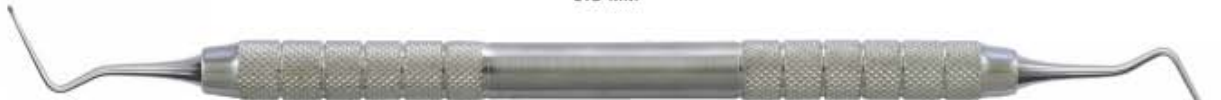

DE-931
0.8 MM



DE-932
1.1 MM



DE-933
1.1 MM



DE-934
1.2 MM



DE-935
1.2 MM



DE-936
1.4 MM



DE-937
1.6 MM



DE-938
1.9 MM







DE-1005
WILLIAMS



DE-1006
WILLIAMS



DE-1007
WILLIAMS



DE-1008



DE-1009



DE-1010



DE-1011



DE-1012



DE-1013



DE-1014



COMPOSITE PLUGGERS INSTRUMENTS



Serrated Pluggers



- | | | | |
|----------|--|------------------|----------|
| Ø 0.9 MM | | DE-1034
OP36M | Ø 1.2 MM |
| Ø 1.1 MM | | DE-1035
OP36D | Ø 1.6 MM |
| Ø 1.6 MM | | DE-1036
Op36 | Ø 2.2 MM |
| Ø 1.0 MM | | DE-1037
Op52 | Ø 1.7 MM |
| Ø 2.2 MM | | DE-1038
Zi51 | Ø 2.6 MM |
| Ø 1.8 MM | | DE-1039
Op44 | Ø 2.2 MM |
| Ø 1.7 MM | | DE-1040
1BR2 | Ø 2.6 MM |
| Ø 2.6 MM | | DE-1041
2BR3 | Ø 3.6 MM |



GUM SCISSORS

- Ножницы десневые
- Ciseaux a gengivas
- Zahnfleissscheren
- Ножиці для ясен
- Tijeras para encias
- مقص صمغ



DE-1335
Iris
115mm
Angled



DE-1336
Iris
115mm
Curved



DE-1337
Goldman-Fox
130mm
Saw edge,
straight



DE-1338
Goldman-Fox
130mm
Saw edge,
curved



DE-1339
Goldman-Fox
130mm
Saw edge,
double curved



DE-1340
La Grange
115mm
Saw edge,
double curved



DE-1341
Neumann
120mm
Saw edge,
double curved



DE-1342
Kilner (Ragnell)
120mm
Straight



DE-1343
Kilner (Ragnell)
120mm
Curved



DE-1344
Joseph
140mm
Straight



DE-1345
Joseph
140mm
Curved



DE-1346
Kelly
160mm
Straight



DE-1347
Kelly
160mm
Curved



DE-1348
Locklin
160mm
Saw edge,
angular



DE-1349
Locklin
120mm
DE-1350
160mm
Saw edge, angular



DE-1351
Dean
170mm
Saw edge,
angular



DE-1352
Spencer
90mm



DE-1353
Spencer
130mm



DE-1354
Spencer
115mm



DE-1355
Noyes
110mm, Straight



DE-1356
Noyes
110mm
Curved



DE-1357
Noyes
110mm
Angular



DE-1358
Castroviejo
150mm
Curved



DE-1042 MF2C
Fuzzi



DE-1043
Pj4



DE-1044 MB3C
Besek



DE-1045
HZ3C



DE-1046
CPRO3C



DE-1047 Mo1
Monari



DE-1048 TH28C
Hirt



DE-1049
HZ25C



DE-1050
Ck10



DE-1051
CK28BC



DE-1052 Op37
Carver



DE-1053
28BR29

Round excavators

Cariology

- for the removal of softened, carious dentin
- for the removal of temporary fillings

Surgery

- to sever the periodontal ligament prior to extraction
- for the removal of granulation tissue after extraction

Design: Round working end Curved cutting edge



Round Excavator, 1.0 mm
DE-1054



Round Excavator, 1.5 mm
DE-1055



Round Excavator, 2.0 mm
DE-1056

Triple-angled back action excavators



Triple-angled Back Action Excavator, 1.0 mm
DE-1057



Triple-angled Back Action Excavator, 1.5 mm
DE-1058



Triple-angled Back Action Excavator, 2.0 mm
DE-1059



Triple-angled Back Action Excavator, 3.5 mm
DE-1060

FILLING INSTRUMENTS

- Инструменты для реставрации
- Instruments pour plombage
- Füllungsinstrumente (mit Kontrawinkel)
- Инструменти для реставрації
- Instrumentos para obturaciones
- ملء الصكوك

COMPOSITE/PLASTIC FILLING INSTRUMENTS SOLID HANDLE 6MM, LENGTH 170MM

BLACK

PLUGGERS/CONDENSERS

Hollenback

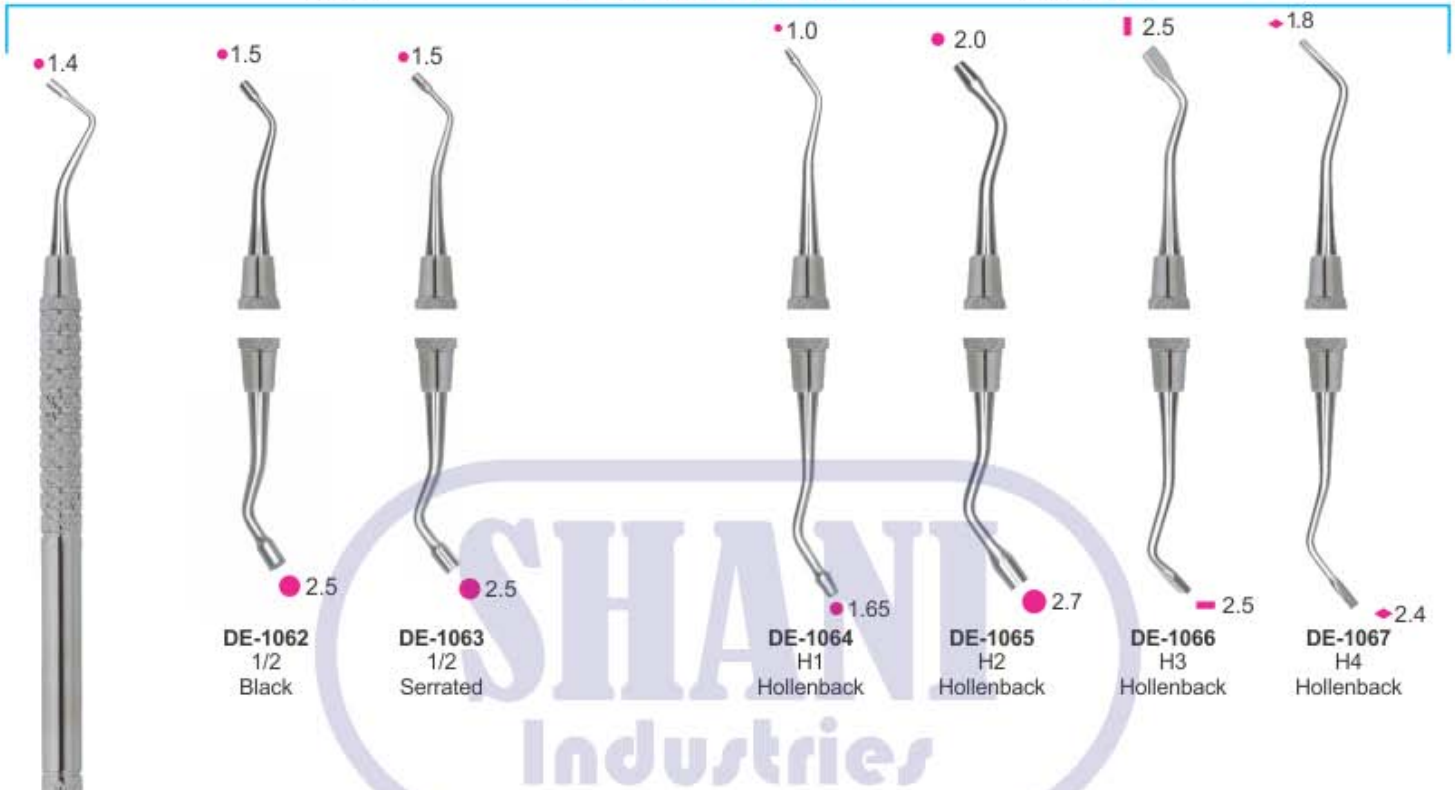

DE-1062
1/2
Black

DE-1063
1/2
Serrated

DE-1064
H1
Hollenback

DE-1065
H2
Hollenback

DE-1066
H3
Hollenback

DE-1067
H4
Hollenback

MARQUETTE CONDENSER

MORTONSON

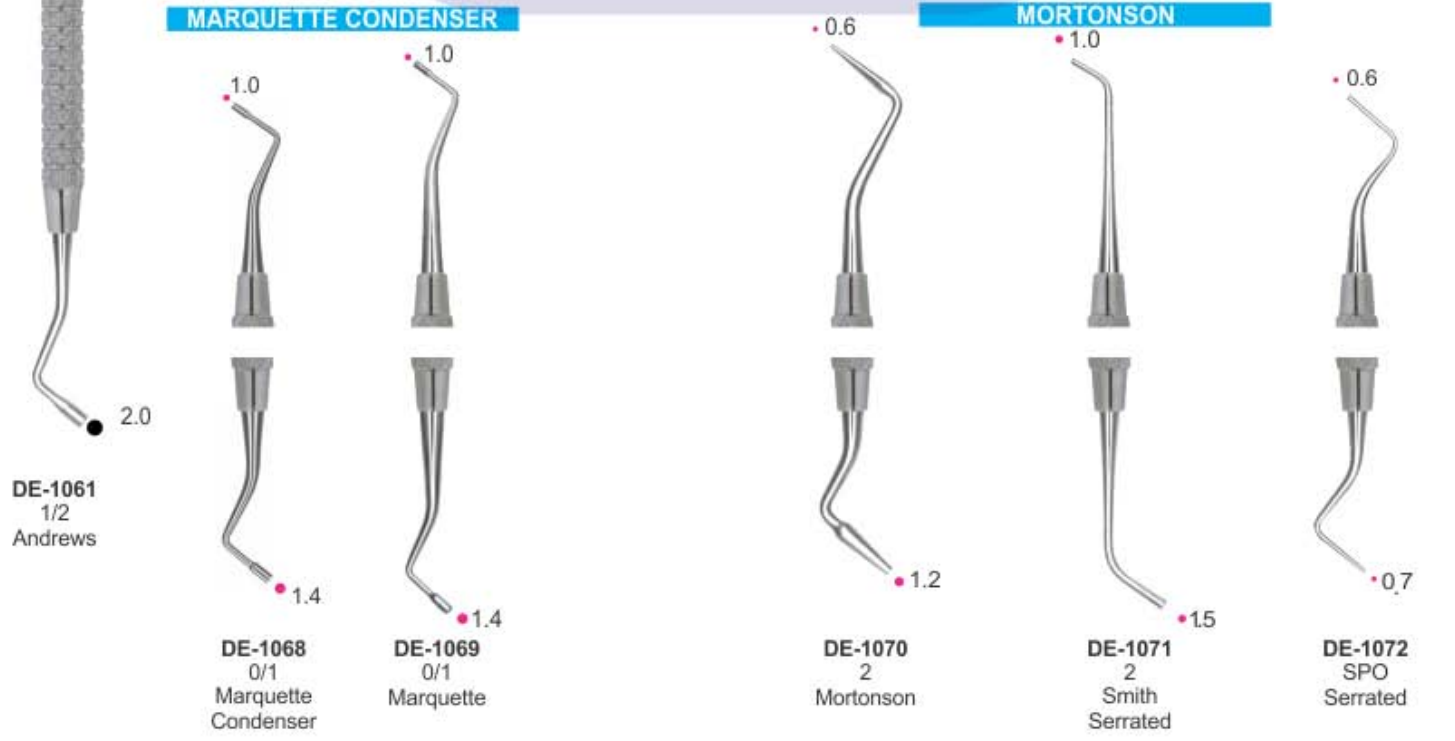

DE-1061
1/2
Andrews

DE-1068
0/1
Marquette
Condenser

DE-1069
0/1
Marquette

DE-1070
2
Mortonson

DE-1071
2
Smith
Serrated

DE-1072
SPO
Serrated



DE-876



DE-877



DE-878



DE-879



DE-880



DE-881



DE-882



DE-883



DE-884



DE-885
PLANATOR



DE-886
PLANATOR

FILLING INSTRUMENTS

- Инструменты для реставрации
- Instruments pour plombage
- Füllungsinstrumente (mit Kontrawinkel)
- Инструменти для реставрації
- Instrumentos para obturaciones
- ملء الصكوك

RESTORATIVE INSTRUMENTS SOLID HANDLE 6MM, LENGTH 170MM Back Action Filling Instruments

Tanner Filling Instruments

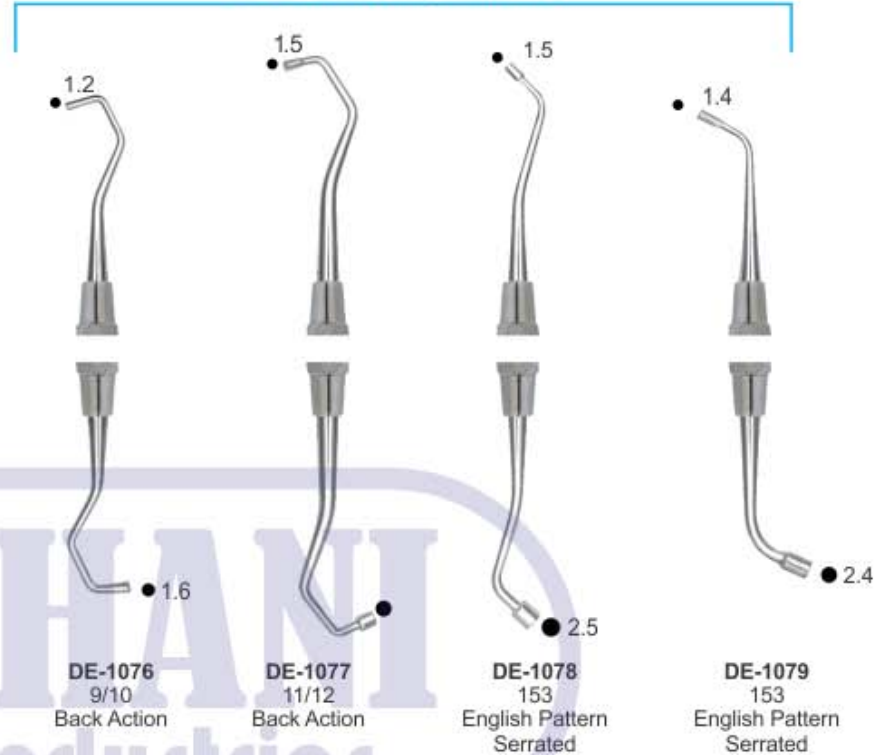

BURNISHERS

BALL

BEAVERTAIL

ACORN

LADMORE

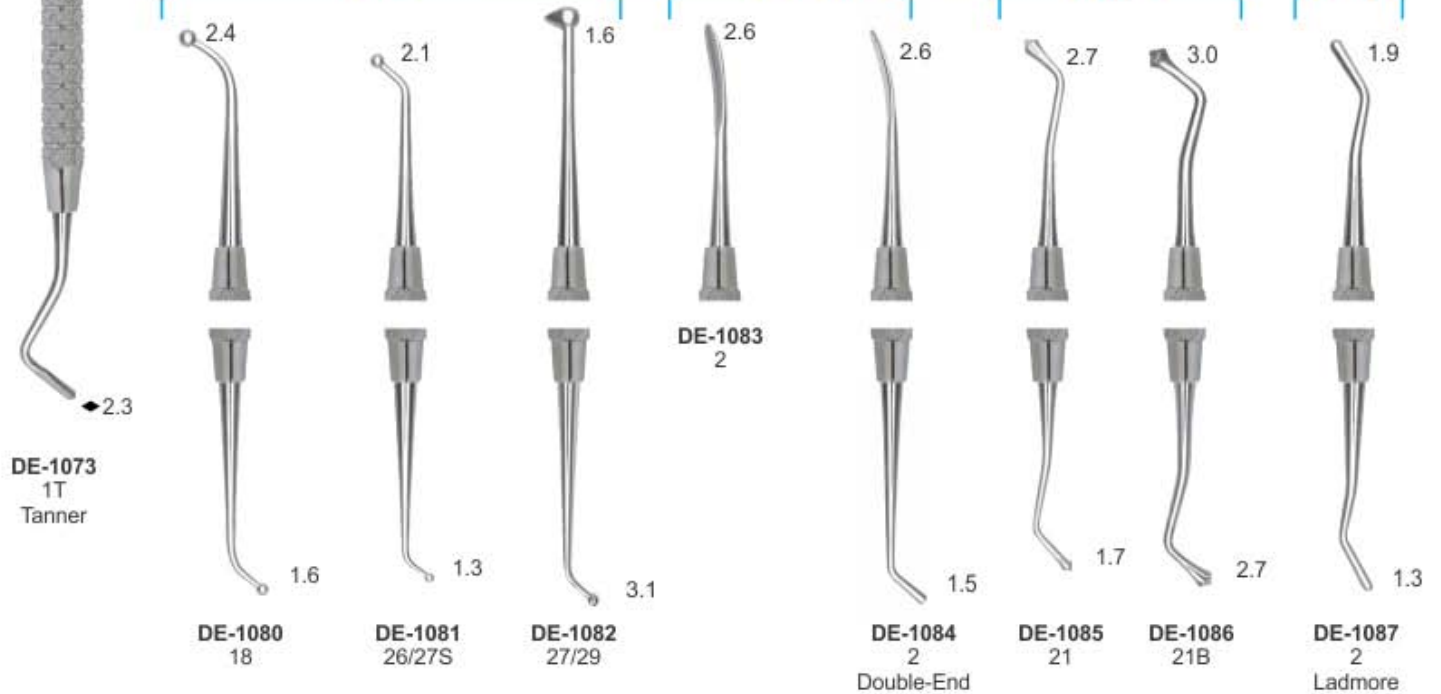

CARVERS INSTRUMENTS

- Инструменты для реставрации
- Instruments a modeler
- Modellierinstrumente
- Инструменти для реставрації
- Instrumentos para modelar
- أدوات تقطيع

P.K. THOMS WAXING INSTRUMENTS SOLID HANDLE 6mm



DE-1095
Composite Instruments Blue
Titanium with Cassettes



DE-1094
P.k. Thomas Waxing Instruments Kit

COMPOSITE INSTRUMENTS TITANIUM BLUE ENDODONTIC

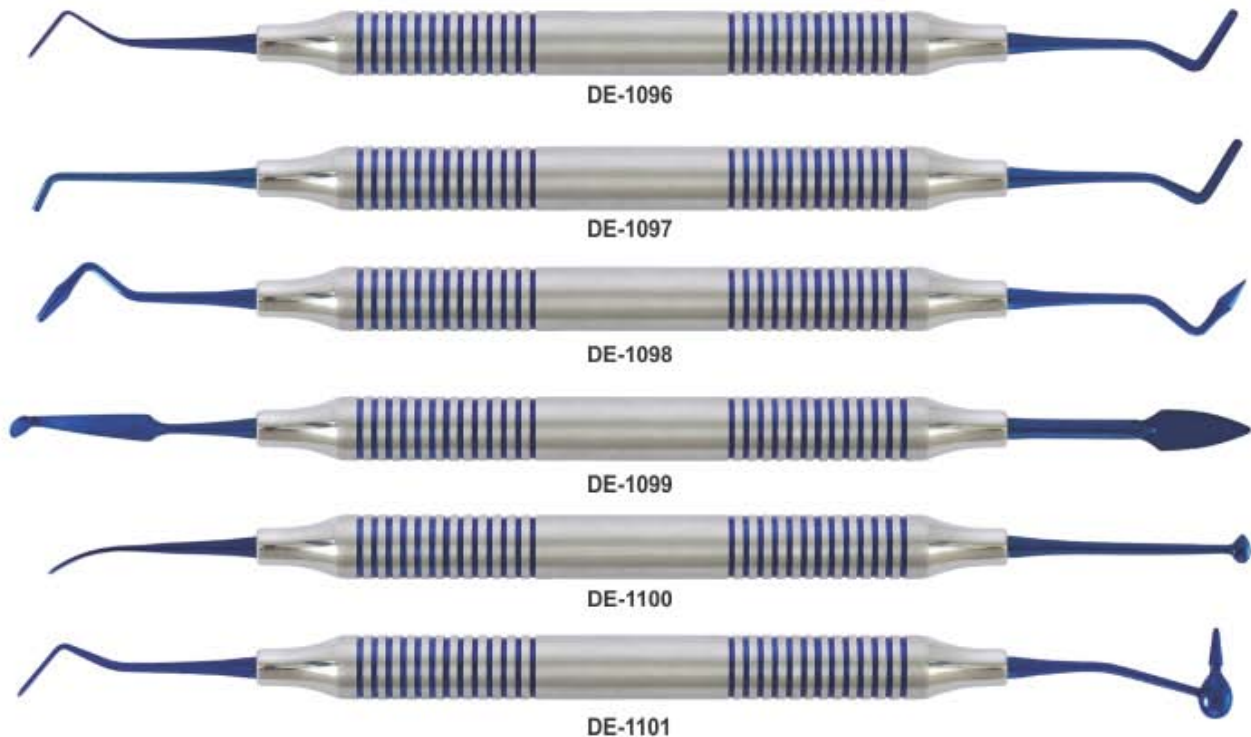

CARVERS INSTRUMENTS

- Инструменты для реставрации
- Instruments a modeler
- Modellierinstrumente
- Инструменти для реставрації
- Instrumentos para modelar
- أدوات تقطيع



DE-1102



DE-1103



DE-1104



DE-1105



DE-1106



Cassette For 5 Instruments
DE-1107

COMPOSITE FILLING INSTRUMENTS

- Инструменты для реставрации
- Instruments pour plombage
- Füllungsinstrumente (mit Kontrawinkel)
- Інструменти для реставрації
- Instrumentos para obturaciones
- ملء الصكوك

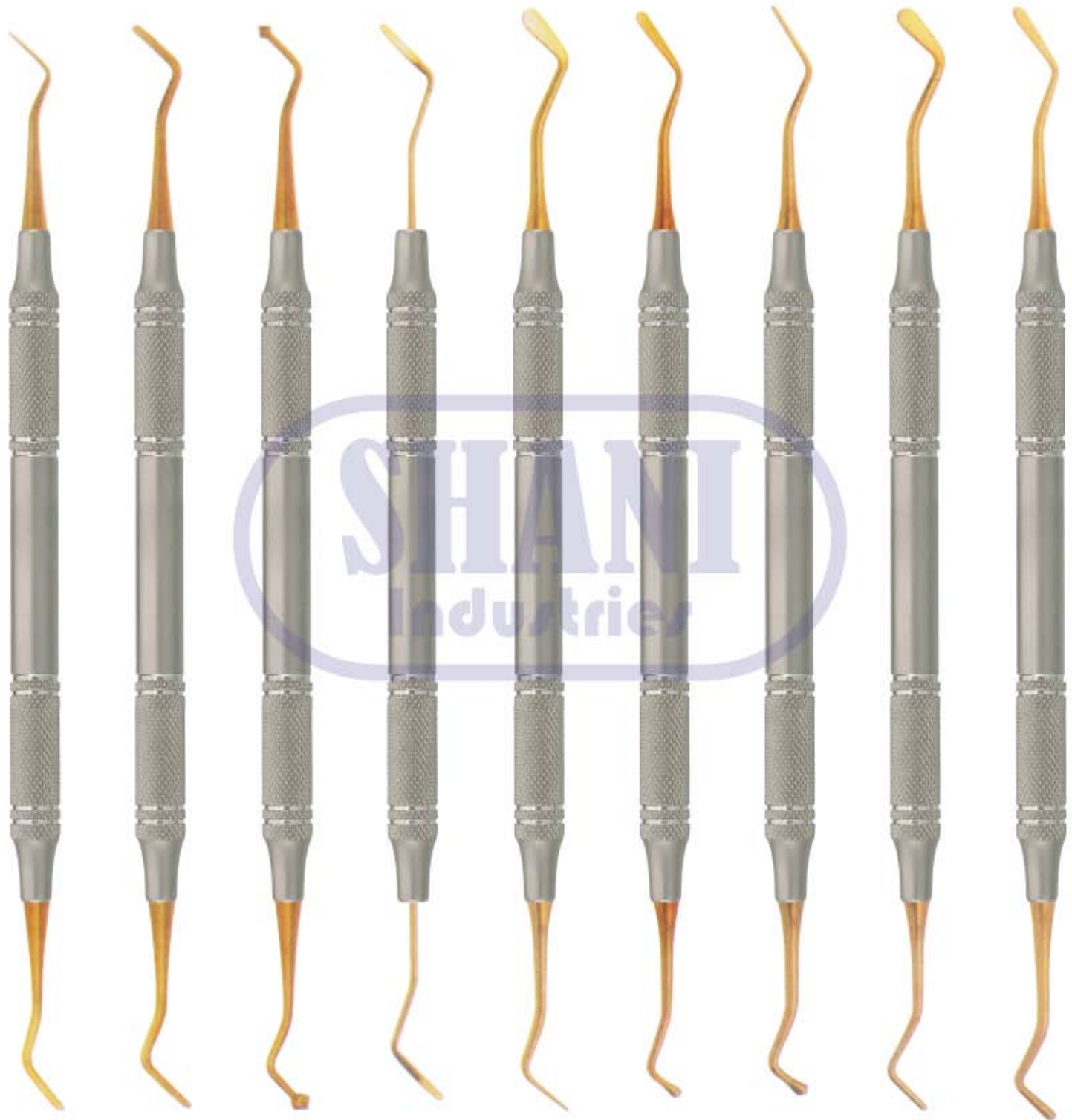

DE-1118

DE-1119

DE-1120

DE-1121

DE-1122

DE-1123

DE-1124

DE-1125

DE-1126

COMPOSITE FILLING INSTRUMENTS



- Инструменты для реставрации
- Instruments pour plombage
- Füllungsinstrumente (mit Kontrawinkel)
- Инструменти для реставрації
- Instrumentos para obturaciones
- ملء الصكوك

Composite Gold Tip Instruments



MISCELLANEOUS PRODUCTS

- Прочие товары
- Divers produits et services
- Sonstige Produkte
- Інші товари
- Varios Productos
- المنتجات المتنوعة



DE-1138
X Ray Film Hangers



DE-1139
X Ray Film Hangers



DE-1140
X Ray Film Hangers



DE-1141
X Ray Film Hangers



DE-1142
X Ray Film Hangers



DE-1143
X Ray Film Hangers



DE-1144
X Ray Film Hangers



DE-1145



DE-1146



DE-1147



Dissecting Set
DE-1148 Set of 9 Pcs.
DE-1149 Set of 11 Pcs.



DE-1150
Napkin Holder with Plastic Chain

DE-1151
Napkin holder with metal chain



Mouth Props
DE-1152
Small

Mouth Props
DE-1153
Medium

Mouth Props
DE-1154
Large

Key Rings



DE-1155



DE-1156



DE-1157



DE-1158



DE-1159



DE-1160

CEMENT SPATULAS

- Шпатели для цемента
- Spatules à ciment
- Zementspatel
- Шпатели для цементу
- Espátulas para cemento
- ملاعق الإسمنت



WAX KNIVES

- Ножи для воска
 - Couteaux a cire
 - Wachsmesser
- Ножи для воску
 - Cuchillos para cera
 - السكين الشمع

ALGINATE, PLASTER SPATULAS, WAX KNIVES PLASTER FOR KNIVES & PLASTER SHEAR



DE-1183
Wooden Handle
Fig. 5
21.5 cm



DE-1184
Wooden Handle
Fig. 7
19.5 cm curved



DE-1185
Wooden Handle
Fig. 8
20 cm curved



DE-1186
Wooden Handle
Fig. 9
22.5 cm curved



DE-1187
Hook Knives



DE-1188
Fig. 1
Lessmann
12.5 cm



DE-1189
Fig. 2
Lessmann
17 cm



DE-1190
Fig. 1
with small spoon
12.5 cm



DE-1191
Fig. 2
with large spoon
17 cm



DE-1192
Bacolite Handle
Wax Knives,
Small



DE-1193
Bacolite Handle
Wax Knives,
Large



DE-1194
Wooden Handle
Wax Knives,
Small



DE-1195
Wooden Handle
Wax Knives,
Large



DE-1196
Plaster Knife



DE-1197
Fig. 1
17 cm



DE-1198
Fig. 3
16 cm



DE-1199
Fig. 4
16 cm



DE-1200
Special Inox
19.5 cm

ARTICULATORS

- Артикуляторы
 - Artocilar
 - Artikulations
- Артикулятори
 - Articuler
 - آرتیکولاتورس



DE-1201

Technical Datas:

Intercondylar distance 120 mm.
 condylar inclination fixed at 30°
 Bennet angle fixed at 7°
 Incisal table inclination 10°
 Distance between mounting plates 85 mm.
 Weight 400 gr.
 Opening (item 5000) 125°
 Opening (item 5010) 180°



DE-1202

Technical Datas:

Intercondylar distance 110 mm.
 condylar inclination fixed at 30°
 Bennet angle fixed at 7°
 Incisal table inclination flat
 Distance between mounting plates 85 mm.
 Weight 450 gr.
 Opening 180°



DE-1203

Stainless Steel Finishing
DE-1204
 Royal Blue



DE-1205



DE-1206



DE-1207



DE-1208



DE-1209



DE-1210



DE-1211



DE-1212



DE-1213



DE-1214
 Nakawalni
 Dental Laboratory
 Instrument

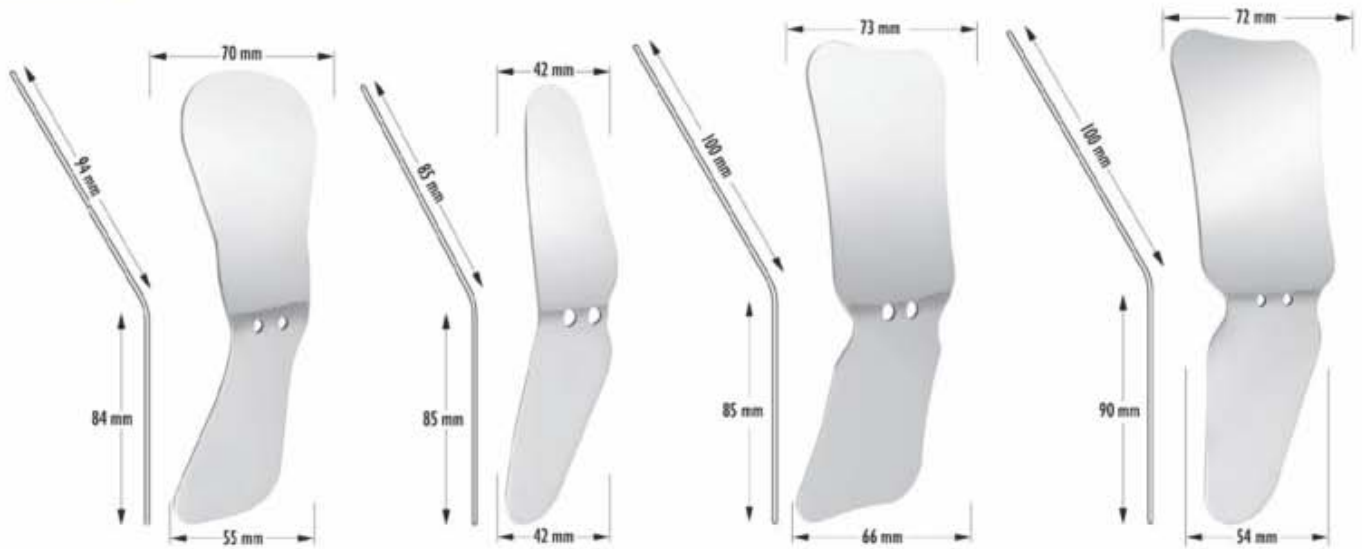

DE-1215 Adult Palatal /
DE-1216 Child Palatal

DE-1217
Buccal

DE-1218 Adult Palatal /
DE-1219 Child Palatal

DE-1220 Adult Palatal /
DE-1221 Adult Buccal

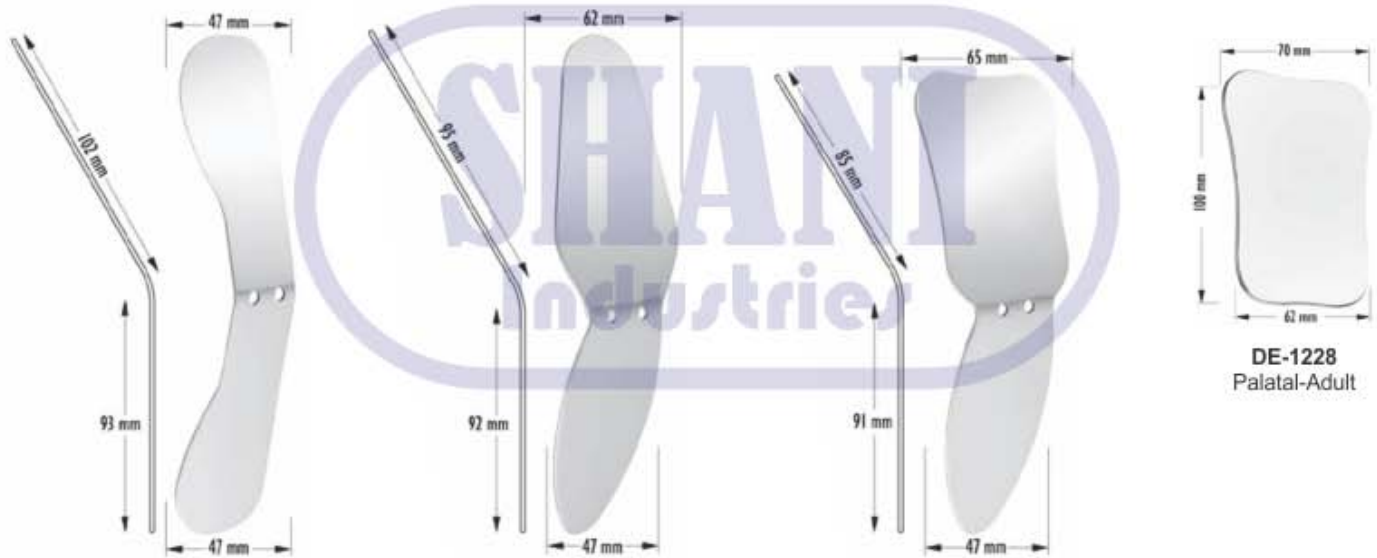

DE-1222 Lingual upper /
DE-1223 Lingual Lower

DE-1224 Adult Buccal /
DE-1225 Child Buccal

DE-1226 Child Palatal /
DE-1227 Child Buccal

DE-1228
Palatal-Adult

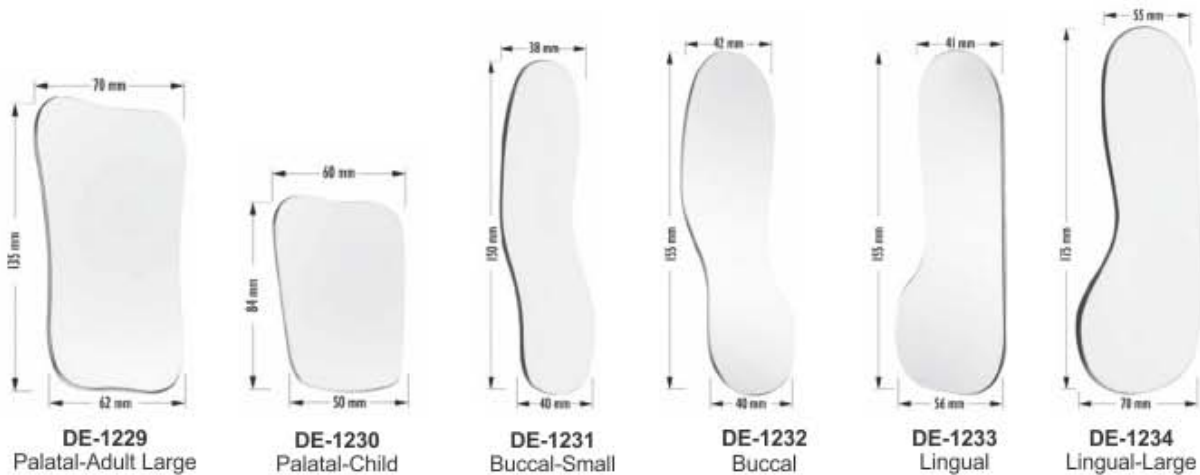

DE-1229
Palatal-Adult Large

DE-1230
Palatal-Child

DE-1231
Buccal-Small

DE-1232
Buccal

DE-1233
Lingual

DE-1234
Lingual-Large

RETRACTORS - MOUTH GAGS

- Роторасширители
- Ecarteurs - Ouvre-bouches
- Vestibulumabhalter / Mundspanner
- Роторозширювачі
- Separadores - Abre-bocas
- الكاشطات - الكمامات الفم



DE-1251
HMG
Heister
130mm



DE-1252
Mouth Gag Molt
11 cm for (Children)



DE-1253
Mouth Gag Molt
14 cm for (Adults)



Sternberg Retractors
DE-1254 140 mm
DE-1255 180 mm



Columbia Retractor
DE-1256 140 mm



DE-1257
Wangen Holder
vestibule
15 cm, with or without
lip protection,



DE-1258
Wangen Holder
vestibule 15 cm, with
or without lip protection



DE-1259
Wangen Holder
with dual
function, 17 cm



Weider Retractor



DE-1260
140 mm



DE-1261
150 mm

RETRACTORS - MOUTH GAGS



- Роторасширители
- Ecarteurs - Ouvre-bouches
- Vestibulumabhalter / Mundspanner
- Роторозширювачі
- Separadores - Abre-bocas
- الكاشطات - الكمامات الفم



Weitlaner
Fig. 1
DE-1262 10.5cm
DE-1263 13.5cm



Weitlaner
Fig. 2
DE-1264 10.5cm
DE-1265 13.5cm



DE-1266
Lip & Cheek Retractor
Stainless Steel
Double Ended



DE-1267
Simplex Retractor
Stainless Steel
Single Ended

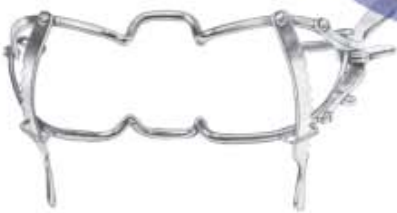
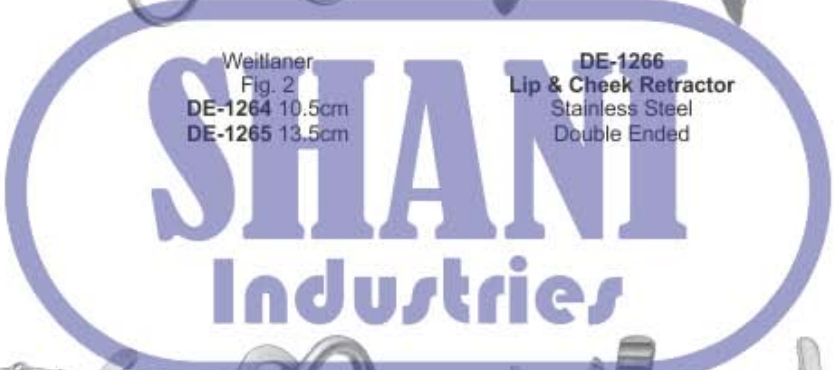

Weitlander
DE-1268 11cm
DE-1269 13cm
DE-1270 15cm



Jennings
DE-1271 11cm
DE-1272 13cm
DE-1273 15cm



DE-1274
Denhard
12 cm



DE-1275
Roser-König
16 cm



DE-1276
Roser-König
19 cm

RETRACTORS

- Ранорасширители
- Ecarteurs
- Wundhaken
- Ранорозширювачі
- Separadores
- الكاشحات

Wound, Bendable
Retractor, individually or as saving kit!



DE-1277
Cheek Retainer
One-sided
Long



DE-1278
Cheek Retainer
One-sided
Long



DE-1279
Cheek Retainer
One-sided
Long



**Ergo Grip
Retractor**
DE-1280 24 cm
ergonomic handle.



Ivory Retractors
Width adjustable
& fixable,
DE-1281 20 cm



Bruenings Retractors
tongue depressors
DE-1282 19 cm



**Minnesota
Retractors**
DE-1283 16 cm



Ribbon Retractors
DE-1284 20 cm
easy to bend
by hand,



Bishop Retractors
retractor and tongue
pushers Bishop with
comfortable margin
DE-1285 16 cm



**Combination
Retractors**
DE-1286 25 cm

RETRACTORS

- Ранорасширители
- Ecarteurs
- Wundhaken
- Ранорозширювачі
- Separadores
- الكاشحات



DE-1287
Unique Retractors
Length 175 mm
angled 45°



DE-1288
Unique Retractors
Length 175 mm
angled 90°



DE-1289
Retractors
16cm



DE-1290
Retractors
19cm



DE-1291
Mini-Langenbeck
Retractors
16 cm, hooks 22 mm



DE-1292
US army Retractors
21 cm, 2



DE-1293
ALM Retractor
about 8 cm



DE-1294
Senn Mueller Retractor
17 cm, hooks 22 mm

RETRACTORS

- Ранорасширители
- Ecarteurs
- Wundhaken
- Ранорозширювачі
- Separadores
- الكاشحات



DE-1295
Langenbeck Retractors
surgical-flat
21 cm, hook
30x16 mm



DE-1296
Langenbeck Retractors
surgical-flat
21 cm, hook
42x11 mm



DE-1297
Langenbeck Retractors
surgical-flat
21 cm, hook
63x12 mm



Langenbeck Retractors
surgical-flat
21 cm, hook
DE-1298 30x16 mm
DE-1299 42x11 mm
DE-1300 63x12 mm



Langenbeck Retractors
21 cm, hook
DE-1301 30x11 mm
DE-1302 30x16 mm



DE-1303
Middelborpf
Retractors
21 cm



DE-1304
Farabeuf
(120 X 12mm
Set of 2 pices)



DE-1305
Retractor Seldin



DE-1306
Feldman Retractor
14cm

GUM SCISSORS

- Ножницы десневые
- Ciseaux a gencives
- Zahnfleischscheren

- Ножиці для ясен
- Tijeras para encias
- مقص صمغ



DE-1307
Iris
115mm
Straight



DE-1308
Iris
115mm
Curved



DE-1309
Goldman-Fox
130mm
Saw edge, straight



DE-1310
Goldman-Fox
130mm
Saw edge, Curved



DE-1311
La Grange
115mm
Saw edge, double Curved



Mayo
DE-1312 140mm
DE-1313 170mm
DE-1314 230mm
Straight



Mayo
DE-1315 140mm
DE-1316 170mm
DE-1317 230mm
Curved



Metzenbaum
DE-1318 145mm
DE-1319 180mm
DE-1320 200mm
Straight



Metzenbaum
DE-1321 145mm
DE-1322 180mm
DE-1323 200mm
Curved



DE-1324
Kelly
160mm
Straight



DE-1325
Kelly
160mm
Curved



DE-1326
Iris
115mm
Straight



DE-1327
Iris
115mm
Curved



DE-1328
La Grange
115mm
Double Curved



DE-1329
Goldman-Fox
130mm, Straight



DE-1330
Goldman-Fox
130mm, Curved



DE-1331
Kelly
160mm, Curved



DE-1332
Iris
115mm, Straight



DE-1333
Iris
115mm, Curved



DE-1334
Micro Iris
90mm, Curved

GUM SCISSORS

NEEDLE HOLDERS

- Ножницы десневые
- Ciseaux a gengivas
- Zahnfleischscheren

- Ножиці для ясен
- Tijeras para encias
- مقص صمغ

- Иглодержатели
- Porte-aiguilles
- Nadelhalter

- Голкотримачи
- Porta-agujas
- اصحاب ابرة



DE-1359
130mm
Straight



DE-1360 Mayo 130mm
DE-1361 Mayo 160mm
DE-1362 Mayo 180mm
Straight Curved

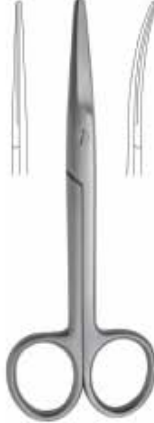

DE-1363 Mayo 140mm
DE-1364 Mayo 200mm
Straight Curved



DE-1365 Metzenbaum 145mm
DE-1366 Metzenbaum 200mm
Straight Curved



DE-1367 Beebee 110mm
Saw edge, straight



DE-1368 Beebee 110mm
Saw edge, curved



DE-1369 Beebe 110mm
Saw edge, straight



DE-1370 Beebe 110mm
Saw edge, curved



DE-1371 Universal 120mm
Saw edge



DE-1372 Universal 120mm

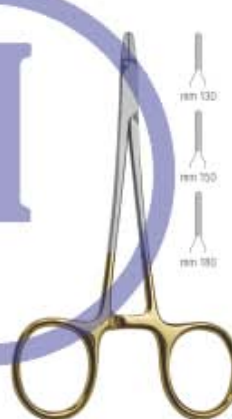

Ryder
DE-1373 130mm
DE-1374 150mm
DE-1375 180mm



DE-1376 Halsey 130mm



DE-1377 Baumgartner 130mm



DE-1378 Derf 120mm



DE-1379 Delicate 150mm



Mayo-Hegar
DE-1380 130mm
DE-1381 160mm
DE-1382 180mm
DE-1383 200mm



DE-1384 Crile-Wood 150mm
straight



DE-1385 Crile-Wood 150mm
curved

NEEDLE HOLDERS

- Иглодержатели
- Porte-aiguilles
- Nadelhalter

- Голкотримачи
- Porta-agujas
- اصحاب ابرة

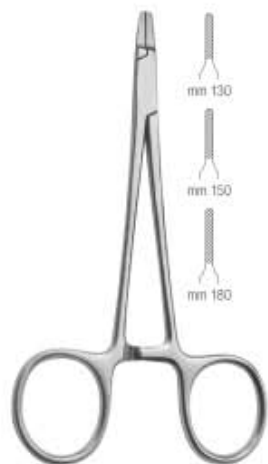

Ryder
DE-1386 130mm
DE-1387 150mm
DE-1388 180mm



DE-1389
Halsey
130mm



DE-1390
Baumgartner
130mm



DE-1391
Derf
120mm



DE-1392
Delicate
150mm



DE-1393
Adson
170mm



Mayo-Hegar
DE-1394 130mm
DE-1395 160mm
DE-1396 180mm
DE-1397 200mm



DE-1398
Crile-Wood
150mm



Castroviejo
DE-1399 str 140mm cvd
DE-1400 str 180mm cvd



Olsen-Hegar Needle
Holder With Scissors
DE-1401 140mm



Gillies Needle
Holder With Scissors
DE-1402 160mm



Mathieu
DE-1403 140mm
DE-1404 170mm



Castroviejo
DE-1405 str 140mm cvd
DE-1406 str 180mm cvd



Olsen-Hegar Needle
Holder With Scissors
DE-1407 140mm



Gillies Needle
Holder With Scissors
DE-1408 160mm

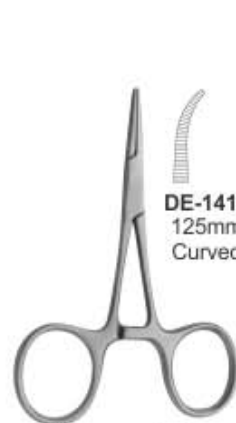

Hartmann (Baby
Mosquito)
DE-1409 90mm straight



Halstead Mosquito
DE-1411 125mm
Straight

DE-1410
125mm
Curved

DE-1412
Curved

GUM SCISSORS

- Ножницы десневые
- Ciseaux a gencives
- Zahnfleischscheren
- Ножиці для ясен
- Tijeras para encias
- مقص صمغ



DE-1413
Goldman Fox Scissors
12.5cm Curved



DE-1414
Iris Scissors
11.5cm Curved
Serrated For Slip-Free Cutting



DE-1415
LaGrange Scissors
11.5cm Double Curved
Serrated For Slip-Free Cutting

Double
Curved



DE-1416
Castroviejo Micro Scissors
12cm Curved



DE-1417
Super Cut Goldman Fox
13.2cm Curved
Serrated For Slip-Free Cutting



DE-1418
Super Cut Iris
11cm Straight
Serrated For Slip-Free Cutting



DE-1419
Super Cut Iris
11cm Curved
Serrated For Slip-Free Cutting

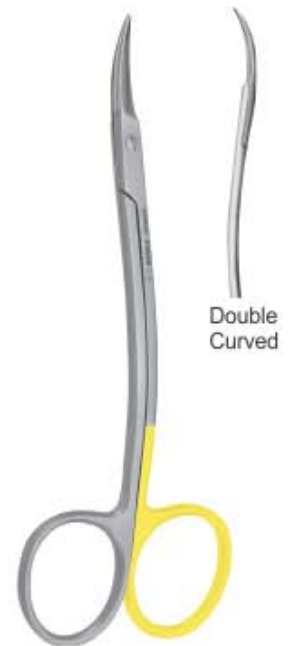

DE-1420
Super Cut LaGrange
11.5cm
Double Curved
Serrated For Slip-Free Cutting

Double
Curved

NEEDLE HOLDERS

- Иглодержатели
- Porte-aiguilles
- Nadelhalter

- Голкотримачи
- Porta-agujas
- اصحاب ابرة



DE-1421
Lichtenberg-
Ryder T.C
14 cm



DE-1422
Lichtenberg-
Ryder T.C
14 cm



DE-1423
Lichtenberg-
Ryder T.C
17 cm



DE-1424
Lichtenberg-
Ryder T.C
17 cm



DE-1425
Barraquer
18 cm



DE-1426
Barraquer
18 cm



DE-1427
Barraquer T.C
18 cm



DE-1428
Barraquer T.C
18 cm



DE-1429
Tönnis
18 cm



DE-1430
Castroviejo
13 cm
Straight



DE-1431
Kalt Needle Holders T.C
14 cm Straight



DE-1432
Peet Splinter Forceps
11.5 cm

DE-1433
La Grange
Curved



DE-1434
All-Purpose Pliers

HAEMOSTATIC FORCEPS & TOWEL CLAMPS

- Зажимы артериальные, зажимы для салфеток
- Pincas hemostatiques, Pincas a compreses
- Arterienklemmen, Tuychklemmen
- Затиски артериальні, затиски для серветок
- Pinzas hemostaticas, Pincas para compresas
- المنقط هيموستاتيک المشبك منشفة

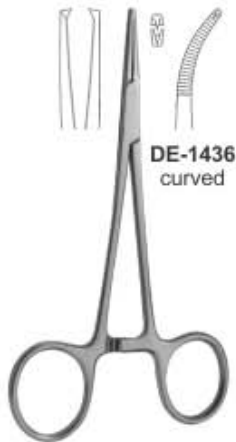

DE-1436
curved

Halstead Mosquito 1x2
DE-1435 125mm
straight

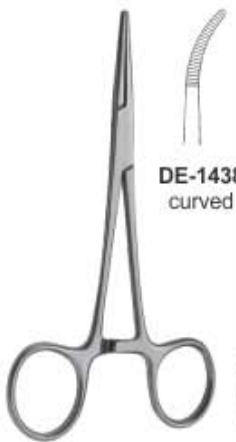

DE-1438
curved

Kelly
DE-1437 140mm
straight

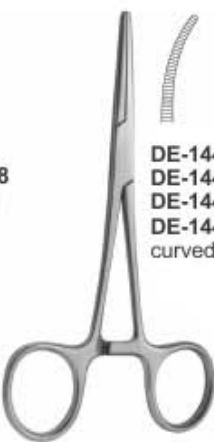

DE-1443 140mm
DE-1444 160mm
DE-1445 180mm
DE-1446 200mm
curved

Rochester-Pean
DE-1439 140mm
DE-1440 160mm
DE-1441 180mm
DE-1442 200mm
straight

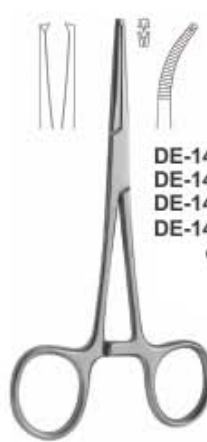

DE-1451 140mm
DE-1452 160mm
DE-1453 180mm
DE-1454 200mm
curved

Rochester-Kocher 1x2
DE-1447 140mm
DE-1448 160mm
DE-1449 180mm
DE-1450 200mm
straight



DE-1456
curved

DE-1455
Kelly-Rankin
160mm
straight



Lorna
DE-1457 100mm
DE-1458 130mm



DE-1459
Allis-Baby 3:4
150mm



DE-1460
Allis 4:5
200mm



DE-1461
Allis 6:7
200mm

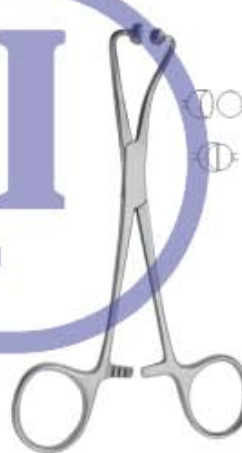

Ball Socket
DE-1462 140mm
Not-perforating and
not-damaging



DE-1463
Backhaus
130mm



DE-1464
Backhaus
85mm



DE-1465
Jones
90mm

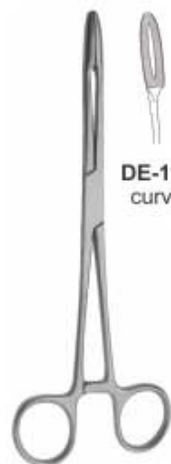

DE-1139
curved

Gross Maier
Dressing Forceps
DE-1466 200mm straight



Foerster
Dressing Forceps
DE-1467 200mm



Spare rubber

Young
Tongue Forceps
DE-1468 170mm



Collins
Tongue Forceps
DE-1469 170mm

RUBBER DAM CLAMPS FORCEPS

- Инструменты для системы коффердам
- Pinces porte-crampons a digue
- Kofferdam Klammerzangen
- Инструменти для системи коффердам
- Pinzas de engrapar para dique de caucho
- السد العطاء الحافظ المشابك



DE-1470

On request the Content of the rubber dam kit can be changed with other instruments.

Content:

- 01 Anisworth
- 02 Brewer
- 03 Clamps Stand
- 04 Denture Plate
- 05 Rubber Dam Frame
- 06 Rubber Dam Box Lower Case
- 07 Rubber Dam Box Upper Case
- 08 Rubber Dam Clamp Fig. 212
- 09 Rubber Dam Clamp Fig. 211
- 10 Rubber Dam Clamp Fig. 8
- 11 Rubber Dam Clamp Fig. 8A
- 12 Rubber Dam Clamp Fig. 14
- 13 Rubber Dam Clamp Fig. 14A
- 14 Rubber Dam Clamp Fig. 0
- 15 Rubber Dam Clamp Fig. 00
- 16 Rubber Dam Clamp Fig. 2
- 17 Rubber Dam Clamp Fig. 2A
- 18 Rubber Dam Clamp Fig. 7

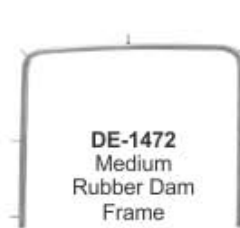

DE-1474
Brewer



DE-1475
Stockes



DE-1476
Palmer



DE-1477
Ivory light weight



DE-1478
Anisworth



DE-1479
Anisworth

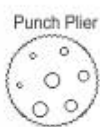

DE-1480
Anisworth



DE-1481
Ivory



DE-1482
Separating Elastic Plier

RUBBER DAM CLAMPS KITS

- Резиновая дамба зажимы комплекты
- Trousses de caoutchouc
- Gummidammklammern
- Гумова дамба затискачі комплекти
- Conjuntos de abrazaderas de retención de caucho
- المطاط السد المشابك مجموعات



DE-1483

Stainless Steel Gold Plated Rubber Dam Clamp Tray with 11 Different Clamps
Fig. 212, 211, 8, 8A, 14, 14A, 0, 00, 2, 2A, 7



DE-1484

Stainless Steel Rubber Dam Clamp Tray with 12 Different Clamps
Fig. 209, 212, 211, 8, 8A, 14, 14A, 0, 00, 2, 2A, 7



DE-1485

Stainless Steel Rubber Dam Clamp Tray with 8 Different Clamps
Fig. 1, 26, 29, 51, 60, 202, 205, 210

DE-1486

Stainless Steel Rubber Dam Clamp Tray
(without clamps)



DE-1487

On request the Content of the rubber dam kit can be changed with other instruments.

Content:

- 01 Ivory
- 02 Ivory light weight
- 03 Clamps Stand
- 04 Rubber Dam Frame M
- 05 Rubber Dam Frame L
- 06 Rubber Dam Box Lower Case
- 07 Rubber Dam Box Upper Case

- 08 Rubber Dam Clamp Fig. 209
- 09 Rubber Dam Clamp Fig. 212
- 10 Rubber Dam Clamp Fig. 211
- 11 Rubber Dam Clamp Fig. 8
- 12 Rubber Dam Clamp Fig. 8A
- 13 Rubber Dam Clamp Fig. 14
- 14 Rubber Dam Clamp Fig. 14A
- 15 Rubber Dam Clamp Fig. 0
- 16 Rubber Dam Clamp Fig. 00
- 17 Rubber Dam Clamp Fig. 2
- 18 Rubber Dam Clamp Fig. 2A
- 19 Rubber Dam Clamp Fig. 7

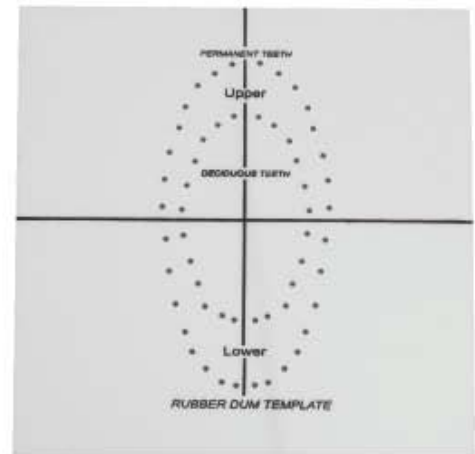

DE-1488
Rubber Dum Template

RUBBER DAM CLAMPS

- Кляммера для коффердама
- Crampons pour digue
- Kofferdam Klammern
- Кляммера для коффердама
- Grapas para dique de caucho
- المشابك المد المطاط



DE-1489
Fig. 15



DE-1490
Fig. 18



DE-1491
Fig. 24



DE-1492
Fig. 25



DE-1493
Fig. 26



DE-1494
Fig. 28



DE-1495
Fig. 30



DE-1496
Fig. 31



DE-1497
Fig. 51



DE-1498
Fig. 138



DE-1499
Fig. 139



DE-1500
Fig. 200



DE-1501
Fig. 201



DE-1502
Fig. 202



DE-1503
Fig. 203



DE-1504
Fig. 204



DE-1505
Fig. 205



DE-1506
Fig. 3



DE-1507
Fig. W3



DE-1508
Fig. 4



DE-1509
Fig. 56A



DE-1510
Fig. 7



DE-1511
Fig. 7A



DE-1512
Fig. 8



DE-1513
Fig. 8A



DE-1514
Fig. W8A



DE-1515
Fig. 10



DE-1516
Fig. 11



DE-1517
Fig. 12A



DE-1518
Fig. 13A



DE-1519
Fig. 14



DE-1520
Fig. 14A



DE-1521
Fig. 14AN



DE-1522
Fig. 22



DE-1523
Fig. 27



DE-1524
Fig. 207



DE-1525
Fig. 29



DE-1526
Fig. 206



DE-1527
Fig. 208



DE-1528
Fig. 209



DE-1529
Fig. 1



DE-1530
Fig. 1A



DE-1531
Fig. 2



DE-1532
Fig. 2A



DE-1533
Fig. W2A



DE-1534
Fig. 0



DE-1535
Fig. 00



DE-1536
Fig. 210



DE-1537
Fig. 211



DE-1538
Fig. 212



DE-1539
Fig. 6



DE-1540
Fig. 9



DE-1541
Fig. N06



DE-1542
Fig. U67



DE-1543
Fig. 214



DE-1544
Fig. P1



DE-1545
Fig. P2



DE-1546
Fig. G-1



DE-1547
Fig. G-2

CROWN REMOVER

- Инструменты для удаления коронок
- Arrache-couronnes
- Teleskopkronenzangen
- Инструменти для видалення коронок
- Arranca-corona
- مزيلات التاج



DE-1548
Crown Spreaders



DE-1550
Universal
Fig. 0



DE-1552



DE-1554

Manual Crown Removers
Handle with 3 tips **DE-1551**
Only 3 tips **DE-1552 to DE-1554**



DE-1556



DE-1558

Manual Crown Removers
Handle with 3 tips **DE-1555**
Only 3 tips **DE-1556 to DE-1558**



DE-1559
Manual Crown
Remover



DE-1560
Manual Crown Remover



DE-1561
Complete with 3 tips
and tightening keys

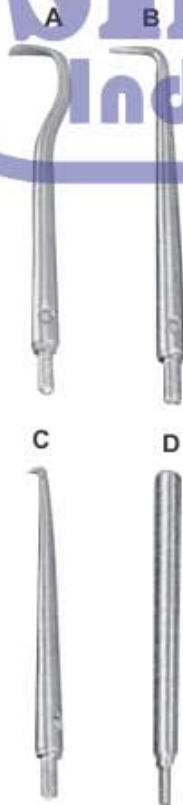

semi-automatic crown
& bridge remover



DE-1562



DE-1563
Manual Crown Remover

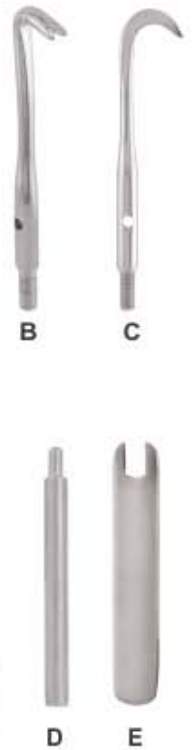

MATRIX RETAINERS

- Матрицедержатели
 - Porte Matrices
 - Matrizenspanner
- Матрицеутримувачи
 - Porta Matrices
 - مصفوفة الخدم



DE-1564
Fig. 5
Ivory 8
5 cm



DE-1565
Fig. 6
Ivory 8
6 cm



DE-1566
Fig. 7
Ivory 8
7 cm



DE-1567
Fig. 1
Tofflemire-Universal



DE-1568



DE-1569



DE-1570



DE-1571
Fig. 2
Tofflemire-Junior



DE-1572
Fig. 3
Tofflemire-Senior



DE-1573
Narrow



DE-1574
Wide



Amalgam Well

DE-1575
Stainless Steel
Amalgam Well



DE-1576
Ivory 12



DE-1577
Ivory 1



DE-1578
Ivory



DE-1579
Elliot

AMALGAM INSTRUMENTS



- Инструменты для амальгамы
- Instruments pour amalgame
- Amalgamisinstrumente
- Инструменты для амальгамы
- Instrumentos para amalgama
- الصكوك الملغم



DE-1580
Fig. 10
165mm
English pattern



DE-1581
Fig. 1
185mm
German pattern



DE-1582
Fig. 1
150mm
Swiss pattern



DE-1583
Fig. 1
150mm



DE-1584
Fig. 2
150mm, 45°



DE-1585
Fig. 3
140mm, 90°



DE-1586
Chip Blower



DE-1587



DE-1588



DE-1589



DE-1590
Water Syringe

AMALGAM INSTRUMENTS

- Инструменты для амальгамы
 - Instruments pour amalgame
 - Amalgamis/strumente
- Инструменты для амальгами
 - Instrumentos para amalgama
 - الصكوك الملقم

AMALGAM CARRIERS

TIP SIZES FOR DISTAL OR SINGLE-END

1.5 mm



DE-1592
Mini/
Single-End

2.0 mm



DE-1593
Regular
Single-End

2.8 mm



DE-1594
Large
Single-End

1.5 mm



DE-1595
Mini
Distal

2.0 mm



DE-1596
Regular
Distal

TIP SIZES FOR DOUBLE-END

1.5 mm



2.0 mm
DE-1597
Mini/
Regular

2.8 mm



2.0 mm
DE-1598
Large/
Regular

3.2 mm



2.0 mm
DE-1599
Jumbo/
Regular



DE-1600
Amalgam
Well

DE-1591
Single-End



TIP SIZES FOR DOUBLE-END



DE-1601 - 1.5mm-2.0mm
DE-1602 - 2.0mm-2.8mm
DE-1603 - 2.0mm-3.2mm

DE-1604 - 1.0mm-2mm
DE-1605 - 2.0mm-3mm
DE-1606 - 2.0mm-4mm



DE-1607 - 1.5mm-2.0mm
DE-1608 - 2.0mm-2.8mm
DE-1609 - 2.0mm-3.2mm

DE-1610 - 1.0mm-2mm
DE-1611 - 2.0mm-3mm
DE-1612 - 2.0mm-4mm



DE-1613 - 1.5mm-2.0mm
DE-1614 - 2.0mm-2.8mm
DE-1615 - 2.0mm-3.2mm

DE-1616 - 1.0mm-2mm
DE-1617 - 2.0mm-3mm
DE-1618 - 2.0mm-4mm



DE-1619 - 1.5mm-2.0mm
DE-1620 - 2.0mm-2.8mm
DE-1621 - 2.0mm-3.2mm

DE-1622 - 1.0mm-2mm
DE-1623 - 2.0mm-3mm
DE-1624 - 2.0mm-4mm



DE-1625 - 1.5mm
DE-1626 - 2.0mm
DE-1627 - 2.0mm
DE-1628 - 3.0mm

CHISELES, BONE FILES & SPOONE CURETTE



DE-1629 DE-1630



DE-1631 DE-1632



DE-1633
4mm
(Straight)



DE-1634
4mm
(Curved)



DE-1635
6mm
(Straight)



DE-1636
6mm
(Curved)

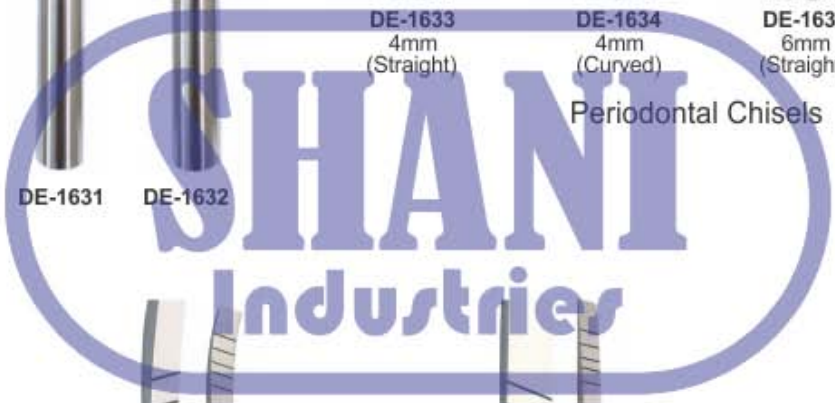

DE-1637



DE-1638



DE-1639



DE-1640

ROOT PLANNING FILES



DE-1641
Kramer-Nevins
Bone Chisel



DE-1642
Kramer-Nevins
Bone Chisel



DE-1643
Molt 18.5cm
Auto Clavable
Plastic Tips

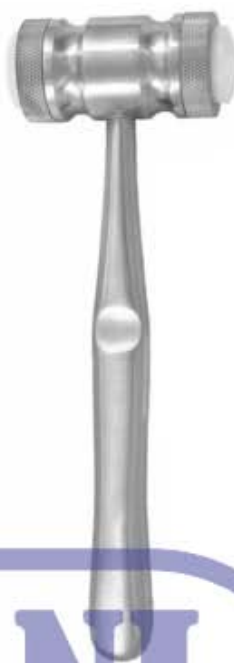

DE-1644
Mead 18.5cm
Non Auto Clavable
Plastic Tips



DE-1645
Miller



DE-1646
Miller



DE-1647
Miller 21



DE-1648
Miller 1X
cross cut



DE-1649
Miller 2X
cross cut



DE-1650
Miller 52



DE-1651
Wahl 1

PERIODONTAL INSTRUMENTS

- Инструменты пародонтологические
- Instruments pour la parodontologie
- Instrumente für die Parodontologie
- Інструменти пародонтологічні
- Instrumentos para periodoncia
- الصكوك اللثة

PERIOSTEEL ELEVATORS



DE-1652
Ohi 10



DE-1653
Howard 9H



DE-1654
Freer



DE-1655
Freer 15



DE-1656
Freer 16



10.0mm

DE-1657



6.4mm

DE-1658
Raspator, Raspatory
Length 175 mm



3.0mm

DE-1659



4.0mm

DE-1660



5.0mm

DE-1661

Raspator, Williger
Length 170 mm, different widths
(4 mm, 5 mm or 7 mm)



7.0mm

DE-1662



Partsch 140 mm
DE-1663 3mm
DE-1664 4mm
DE-1665 5mm
DE-1666 6mm



Partsch 170 mm
DE-1667 3mm
DE-1668 4mm
DE-1669 5mm
DE-1670 6mm



Partsch 140 mm
DE-1671 3mm
DE-1672 4mm
DE-1673 5mm
DE-1674 6mm

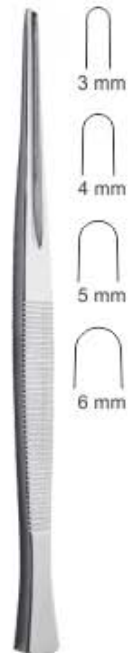

Partsch 170 mm
DE-1675 3mm
DE-1676 4mm
DE-1677 5mm
DE-1678 6mm

- Инструменты пародонтологические
- Instruments pour la parodontologie
- Instrumente für die Parodontologie
- Инструменти пародонтологічні
- Instrumentos para periodoncia
- الصكوك اللثة

To separate tissue tooth or bone. tp hold tissue away from surgical site.



PERIODONTAL INSTRUMENTS

- Инструменты пародонтологические
- Instruments pour la parodontologie
- Instrumente für die Parodontologie
- Инструменти пародонтологічні
- Instrumentos para periodoncia
- الصكوك اللثة



DE-1689



DE-1690
P24G



DE-1691
titanium Periosteal Elevator for Implan5



DE-1692
S1



DE-1693
Hirschfeld



DE-1694
9S



10mm

DE-1695
Selden

13mm

4.8 mm

Prichard

10.6 mm

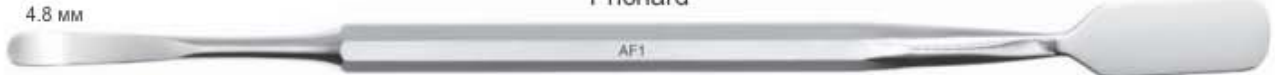

DE-1696
Friedmann



DE-1697
Schmidlin

6.9 mm

SCALPEL HANDLES

- Ручки для скальпелей
 - Manches de bistouris
 - Skalpellgriffe
- Ручки для скальпелів
 - Mangos de bisturi
 - مشرط مقابض



DE-1698
Fig.3
12.7cm



DE-1699
Fig.3G
12.7cm



DE-1700
Fig.4
13.7cm



DE-1701
Double Handle
No.4 + No.3
16.3cm



DE-1702
Fig. 7
16.5cm

SHANI
Industries



DE-1703
Scalpel Handle Straight
for blades #10-15
14.5cm



DE-1704
Micro Surgical Scalpel
Handle titanium
13.5cm



DE-1705
Fig. 5
14.5cm



DE-1706
Fig. 5A
14.5cm



DE-1707
6 Way Adjustable Angled
Scalpel Handle



DE-1708
Metal tip
220 mm
Hammer With Wooden Handle



DE-1709
Metal tip
220 mm



DE-1710
1
For plaster



DE-1711
2
For metal



DE-1712
Fret saw
250 mm



DE-1713
Small
Saw Blades



DE-1714
Large
Saw Blades



DE-1715
Ceri Saw



Special Inox
DE-1716 170mm
DE-1717 200mm



DE-1718
Plaster Shears
200 mm



Crucible Tongs
DE-1719 250 mm
DE-1720 320 mm



DE-1721
Ceri Saw
180 mmm



DE-1722
Blade
0,12x5 mm
Conf. 12 pcs



DE-1723
Blade
0,25x5 mm
Conf. 12 pcs



DE-1724
Blade
0,25x3 mm
Conf. 12 pcs



Behind Every Smile is a Story

- QUALITY - ЯКІСТЬ
- PRECISION - ТОЧНІСТЬ
- ACCURACY - ПРАВИЛЬНІСТЬ
- DURABILITY - ЗНОСОСТІЙКІСТЬ



STYLE A

STYLE B

- Super-duty diamond beaded surfaces
- smooth ultra-polished and beveled edges
- brilliant corrosion resistant stainless steel finish
- superior T-11 stainless steel head handle
- smooth ultra-polished and beveled edges
- brilliant corrosion resistant stainless steel finish
- sliding lock joint for balance & precision alignment
- sliding lock joint for balance & precision alignment

ORTHODONTIC INSTRUMENTS



- Инструменты ортодонтические
- Instrumentos Ortodonticos
- Orthodontische Instrumente
- Инструменти ортодонтични
- Instruments Orthodontiques
- أدوات تقويم الأسنان



DE-1800
Height Gauge 0.18
Aluminum



DE-1801
Height Gauge 0.22
Aluminum



DE-1802
Height Gauge 0.18
Stainless Steel



DE-1803
Height Gauge 0.22
Stainless Steel



DE-1804
Moveable
Height Gauge



DE-1805
Endo Finger
Ruler Span
Measure Scale



DE-1806
Endo Finger
Ruler Span
Measure Scale



DE-1807
Endo Finger
Ruler Span
Measure Scale



DE-1808
Positive
Postioner



DE-1809
Strip Saw



DE-1810
Bone Bracket Gauge



DE-1811
Endo Finger Ruler
Span Measure Scale



DE-1812
Endo Finger Ruler
Span Measure Scale

ORTHODONTIC INSTRUMENTS

- Инструменты ортодонтические
- Instrumentos Ortodonticos
- Orthodontische Instrumente
- Инструменти ортодонтични
- Instruments Orthodontiques
- أدوات تقويم الأسنان



DE-1813
Measuring Loop
angled, length
175 mm,
measuring range
0 - 40 mm



DE-1814
Measuring Loop
straight length
175 mm,
measuring range
0 - 40 mm



DE-1815
Measuring loop, Castroviejo
angled, length 175 mm,
measuring range 0 - 40 mm,
with window



DE-1816
Measuring Loop
straight length 90 mm,
measuring range
0 - 40 mm,

DE-1817
Castroviejo Calipers
20mm
90mm



DE-1818
Measuring Loop
angled, length 90 mm,
measuring range
0 - 40 mm,

DE-1819
Castroviejo Calipers
20mm, 45°
90mm



DE-1820
Castroviejo Calipers
20mm
90mm



DE-1821
Fig. 1
Iwanson
spring caliper
For metal and
porcelain.



DE-1822
Fig. 2
Iwanson
spring caliper
For wax.

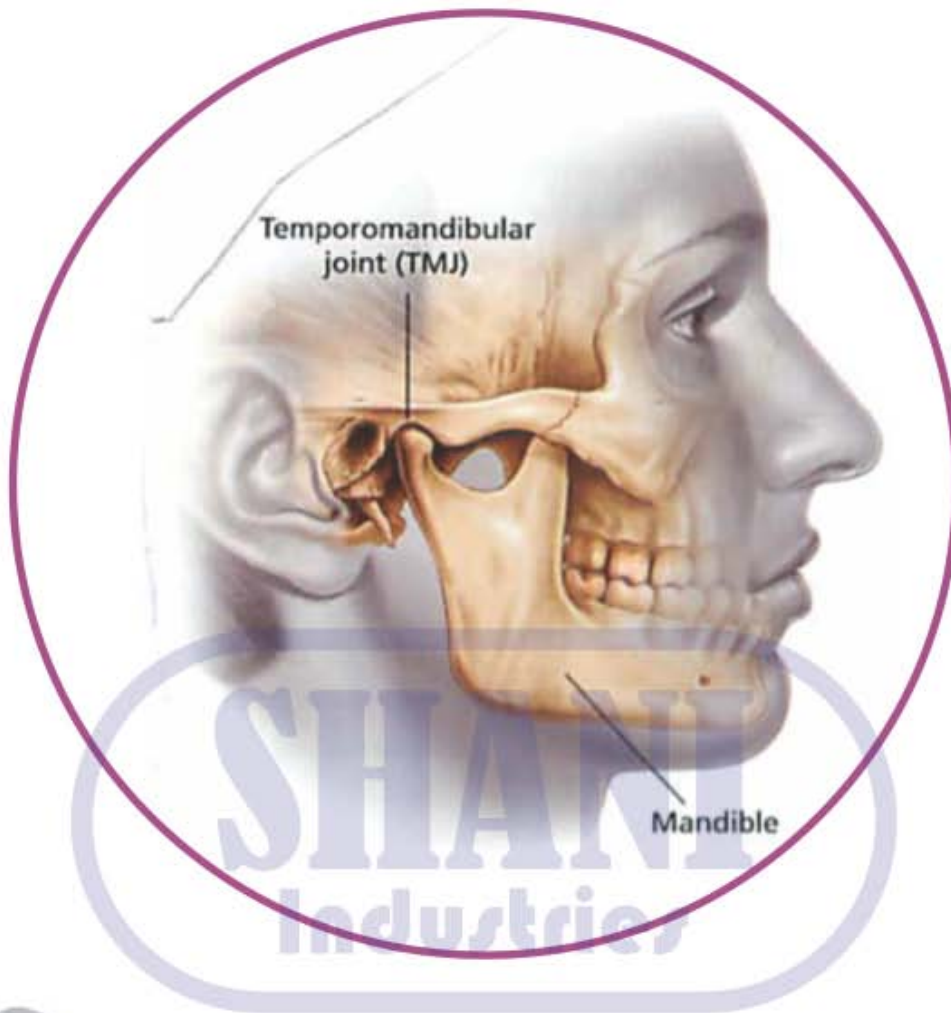

ORTHODONTIC INSTRUMENTS

- Инструменты ортодонтические
- Instrumentos Ortodonticos
- Orthodontische Instrumente
- Инструменти ортодонтични
- Instruments Orthodontiques
- أدوات تقويم الأسنان



DE-1864
Ortho light scaler double ended



DE-1865
Ortho light scaler double ended



DE-1866
Ortho light scaler double ended



DE-1867
Twiel-on elastic module instrument



DE-1868
Twiel-on elastic module instrument



DE-1869
Schure Band Seater



DE-1870
Ortho light scaler



DE-1871
Ortho light scaler



DE-1872
Ortho light scaler heavy



DE-1873
Ortho instrument



DE-1874
Ortho instrument

ORTHODONTIC INSTRUMENTS



- Инструменты ортодонтические
- Instrumentos Ortodonticos
- Orthodontische Instrumente
- Инструменти ортодонтични
- Instruments Orthodontiques
- أدوات تقويم الأسنان



DE-1875
Ortho Light double ended
ligature director



DE-1876
Ortho Light double ended ligature scaler director tivate coil spring
are remove modules with one instruments



DE-1877
Ortho band pusher scaler



DE-1878
Ortho ligature director single ended



DE-1879
Ortho Light double ended ligature
director scaler



DE-1880
Ortho Light double ended ligature scaler/director
tivate coil spring are remove modules with one instruments



DE-1881
Ortho Light double ended ligature director



DE-1882
Ortholite Ligature Director Scaler



DE-1883
Ortho light ligature director double ended



DE-1884
Double ended cement spatula



DE-1885
Ortho light scaler single ended

- Щипцы для ортодонтии и протезирования
- Pincers pour l'orthodontie et la prothèse
- Zangen für Kieferorthopädie und Prothetik
- Щипці для ортодонції та протезування
- Alicates para ortodoncia y prótesis
- كمشة لتقويم الأسنان بروستھتیس

BOX JOINT PLIERS

DE-1886

Universal Dolphin Style
Wire Bending & cutting pliers



DE-1892

Bracket Removing Plier curved
Bracket Removing Plier curved for
easy removal of brackets in the
posterior region. Length 130mm



DE-1887 Band Removing Plier

The curved blade of the band
removing plier can strip easily
and gently remove directly to
the tooth. Length 130mm



DE-1893

Young Wire Bending &
Loop Forming Pliers



DE-1888

Tweed Loop
forming Pliers



DE-1894

Wire Bending &
Loop Forming Pliers



DE-1889

How Plier curved
Universally usable tool for
the multiband technology for
wires up to .028".
Length 130mm



DE-1895

Adams, small wire bending
and loop forming Pliers



DE-1890 How Plier

Universally usable tool for the
multiband technology for wires
up to .028".
Length 135mm



DE-1896

Bracket Removing Plier Round Box
Bracket removing plier for comfortable
and quick removal of the brackets.
Length 135mm



DE-1891

Nance Loop
forming Pliers



DE-1897

Weingart Plier medium
Weingart plier that are ideal due to
their curved tip for setting sheets and
is capable of bending the ends.
Length 145mm



PLIERS FOR ORTHODONTICS & PROSTHETICS



- Щипцы для ортодонтии и протезирования
- Пинцес pour l'orthodontie et la prothèse
- Zangen für Kieferorthopädie und Prothetik
- Щипці для ортодонції та протезування
- Alicates para ortodoncia y prótesis
- كمانة لتقويم الأسنان بروستتیس

BOX JOINT PLIERS

DE-1898 Adams Plier Round Box
Adams pliers for bending wire arches and bends right angles for wires up to .022", .025 tip to beak. Length 125mm



DE-1904 Adams Plier
Adams pliers for bending wire arches and bends right angles for wires up to .022", .025 tip to beak. Length 125mm



DE-1899 Falcon Beak Contouring Pliers.



DE-1905 Tweed Loop Formin Pliers



DE-1900
wires up to 0.020" / 0.7mm.



DE-1906 Bird Beak Plier Standard
Bird Beak Wire bending plier without notches, which is suitable as a universal utility tool. Length 125mm



DE-1901 Johnson Contouring Pliers



DE-1907 Mini Ligature cutters



DE-1902 Aderer Large wire bending and loop forming pliers



DE-1908 Small Fluch-cut distal and cutting Pliers with safety hold fitted with un-breakable, corrosion resistant and durable stainless steel tips



DE-1903 Tweed / angle rectangular arch forming & Torquing pliers



DE-1909 Large Fluch-cut distal and cutting Pliers with safety hold fitted with un-breakable, corrosion resistant and durable stainless steel tips



- Щипцы для ортодонтии и протезирования
- Pincers pour l'orthodontie et la prothèse
- Zangen für Kieferorthopädie und Prothetik
- Щипці для ортодонції та протезування
- Alicates para ortodoncia y prótesis
- كمشة لتقويم الأسنان بروستھتیس

BOX JOINT PLIERS

DE-1910

Tweed / Angel

1.78mm (.070") wide tips arch forming and torquing pliers



DE-1916

Contouring Plier



DE-1911

Tweed / Angel

1.78mm (.070") wide tips arch forming and torquing pliers



DE-1917

Bands & Crowns Plier
in order to skirt



DE-1912

Lingual / Palatal arch forming pliers



DE-1918

Ligature Forming Pliers



DE-1913

Aderer

Facebow loop forming Pliers



DE-1919

for double back and triple back bands in 0.30" / 0.76mm & 0.36" / 0.91mm lingual arch wires



DE-1914

Waldsahvs wire bending and cutting pliers



DE-1920

Bird Beak Wire Bending & cutting pliers



DE-1915 Aderer Plier

For the manufacturing of appliances and activation of wires for wires up to .030" .fine tip and up to .036" mean tip. Length 130mm



DE-1921

Weingart Plier medium

Weingart plier that are ideal due to their curved tip for setting sheets and is capable of bending the ends. Length 145mm



PLIERS FOR ORTHODONTICS & PROSTHETICS



- Щипцы для ортодонтии и протезирования
- Pincas pour l'orthodontie et la prothèse
- Zangen für Kieferorthopädie und Prothetik
- Щипці для ортодонції та протезування
- Alicates para ortodoncia y prótesis
- كمانة لتقويم الأسنان بروستhetics

L-KEY JOINT PLIERS



DE-1922
Distal end cutter with safety hold, mini head, long handles.
fitted with un-breakable, corrosion resistant and durable stainless steel tips

- 0.30 mm to 0.50 mm (.012" to .020")
- Max. 0.46 mm x 0.64 mm (.018" x .025")
- ⊗ 0.38 mm to 0.53 mm (.0155" to .0215")
- ⊗ Max. 0.53 mm x 0.64 mm (.021" x .025")



DE-1923
Flush-cut distal end cutter with safety hold fitted with un-breakable, corrosion resistant and durable stainless steel tips

- 0.30 mm to 0.50 mm (.012" to .020")
- Max. 0.46 mm x 0.64 mm (.018" to .025")



DE-1924
Soft wire and ligature cutter, Mini fitted with un-breakable, corrosion resistant and durable stainless steel tips

- ⌋ .25 mm to .38 mm (.010" to .015")



DE-1925
Soft wire and ligature cutter, standard fitted with un-breakable, corrosion resistant and durable stainless steel tips

- ⌋ .25 mm to .38 mm (.010" to .015")



DE-1926
Soft wire and ligature cutter, 15° angled fitted with un-breakable, corrosion resistant and durable stainless steel tips

- ⌋ .25 mm to .38 mm (.010" to .015")



DE-1927
Soft wire and ligature cutter, 45° angled fitted with un-breakable, corrosion resistant and durable stainless steel tips

- ⌋ .25 mm to .38 mm (.010" to .015")



DE-1928
Hard wire cutter, straight Fitted with un-breakable, corrosion resistant and durable stainless steel tips

- 0.30 mm to 0.50 mm (.012" to .020")
- Max. 0.56 mm x 0.71 mm (.022" x .028")



DE-1929
Hard wire cutter, 15° angled Fitted with un-breakable, corrosion resistant and durable stainless steel tips

- 0.30 mm to 0.50 mm (.012" to .020")
- Max. 0.56 mm x 0.71 mm (.022" x .028")



DE-1930
Hard wire cutter, 15° angled Non-autoclavable

- 0.30 mm to 0.50 mm (.012" to .020")
- Max. 0.56 mm x 0.71 mm (.022" x .028")

- Щипцы для ортодонтии и протезирования
- Pincers pour l'orthodontie et la prothèse
- Zangen für Kieferorthopädie und Prothetik
- Щипці для ортодонції та протезування
- Alicates para ortodoncia y prótesis
- كاشطة لتكويم الأسنان بروستيتيس

L-KEY JOINT PLIERS



DE-1931
Band removing pliers



DE-1932
Bracket removing pliers angled



DE-1933
Bracket removing pliers straight



DE-1934
Bracket removing pliers with plastic tip



DE-1935
Adhesive removing pliers



DE-1936
Weingart-mini
Utility Pliers

- 0.30 mm to 0.50 mm (.012" to .020")
- Max 0.56 mm x 0.71 mm (.022" x .028")

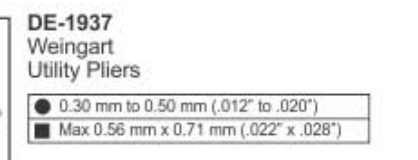

DE-1937
Weingart
Utility Pliers

- 0.30 mm to 0.50 mm (.012" to .020")
- Max 0.56 mm x 0.71 mm (.022" x .028")



DE-1938
How Straight
Utility Pliers

- 0.30 mm to 0.50 mm (.012" to .020")
- Max 0.56 mm x 0.71 mm (.022" x .028")

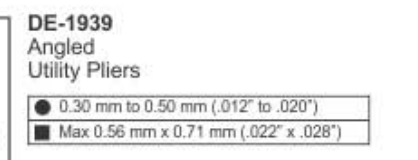

DE-1939
Angled
Utility Pliers

- 0.30 mm to 0.50 mm (.012" to .020")
- Max 0.56 mm x 0.71 mm (.022" x .028")



DE-1940
Wire bending and loop forming pliers
Angled (Bird beak)

- 0.30 mm to 0.50 mm (.012" to .020")
- Max 0.56 mm x 0.71 mm (.022" x .028")

PLIERS FOR ORTHODONTICS & PROSTHETICS



- Щипцы для ортодонтии и протезирования
- Pincers pour l'orthodontie et la prothèse
- Zangen für Kieferorthopädie und Prothetik
- Щипці для ортодонції та протезування
- Alicates para ortodoncia y prótesis
- كمانة لتقويم الأسنان برومشتينس

L-KEY JOINT PLIERS



DE-1941
Multi-purpose pliers, bird beak,
De la rosa and cutter in one

- 0.30 mm to 0.50 mm (.012" to .020")
- Max. 0.46 mm x 0.56 mm (.018" x .022")



DE-1946
Stop pliers V-Bebd - 1mm

- 0.30 mm to 0.50 mm (.012" to .020")
- Max. 0.43 mm x 0.56 mm (.017" x .028")



DE-1942
Cinch Back / tie back
Distal end bending pliers

- 0.30 mm to 0.50 mm (.012" to .020")
- Max. 0.56 mm x 0.71 mm (.022" x .028")



DE-1947
Lingual / palatal arch forming pliers

- 0.76 mm (.030") / 0.91 mm (.036")



DE-1943
Hammer head
Distal end bending pliers

- 0.30 mm to 0.50 mm (.012" to .020")
- Max. 0.56 mm x 0.71 mm (.022" x .028")



DE-1948
Torquing pliers set



DE-1944
Nance
Loop forming pliers

- 0.36 mm to 0.71 mm (.014" to .028")
- Max. 0.56 mm x 0.71 mm (.022" x .028")



DE-1949
Tweed / angel
Rectangular arch forming and
torquing pliers

- 0.30 mm to 0.71 mm (.012" to .028")
- Max. 0.56 mm x 0.71 mm (.022" x .028")



DE-1945
Detailing step pliers / Bayonet
bending pliers - 1mm

- 0.30 mm to 0.50 mm (.012" to .020")
- Max. 0.56 mm x 0.71 mm (.022" x .028")



DE-1950
Surgical ball hook crimping pliers,
angled



DE-1951
Surgical ball hook crimping
pliers, straight

PLIERS FOR ORTHODONTICS & PROSTHETICS

- Щипцы для ортодонтии и протезирования
- Pincers pour l'orthodontie et la prothèse
- Zangen für Kieferorthopädie und Prothetik
- Щипці для ортодонції та протезування
- Alicates para ortodoncia y prótesis
- كمانة لتقويم الأسنان بروستيتيس

L-KEY JOINT PLIERS



DE-1952
Aderer Clamp three jaw wire bending plier for contouring and bending wire up to .30"/.76mm.



DE-1958
Falcon beak contouring plier.



DE-1953
Bird beak plier for bending round, square and rectangle wire up to .30"/.76mm.

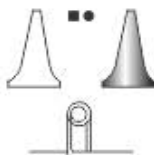

DE-1959
For placement and removal of arch wires, pins and other auxiliaries.



DE-1954
Bird beak plier for light wire bending round, square and rectangular up to .016"/0.41mm.



DE-1960
For placement and removal of arch wires, pins and other auxiliaries in angle design



DE-1955
Double Rounded jaw bending pliers, hooks and wire up to .020"/0.51mm.

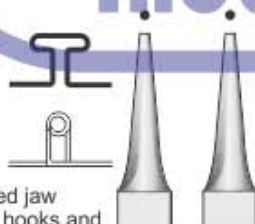

DE-1961
contouring Plier.



DE-1956
Adams pliers for hooks and bending wire up to .030"/0.76mm.

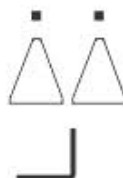

DE-1962
Bending plier. In order to skirt molares bands. With grooved. Recommended wire. 016", 018" and 022" 0.41mm, 0.46mm and 0.56mm



DE-1963
Loop forming in four length 3, 4, 5 & 6 mm wire capacity 0.22", 0.56mm.



DE-1957
Johnson pliers for crown band contouring



DE-1964
Arch bending plier design for convenient handling of square or rectangular wire, .020" / 0.51mm.



PLIERS FOR ORTHODONTICS & PROSTHETICS



- Щипцы для ортодонтии и протезирования
- Пинцес pour l'orthodontie et la prothèse
- Zangen für Kieferorthopädie und Prothetik
- Щипці для ортодонції та протезування
- Alicates para ortodoncia y prótesis
- كمانة لتقويم الأسنان بروستتیس

LAP & L-KEY JOINT PLIERS



DE-1965
In order to skirt bands and crowns.



DE-1966
Wires up to .020" / 0.7mm.

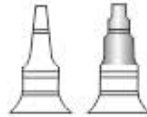

DE-1967
Round and concave plier for loop forming and banding wire up to .20" / .051mm.



DE-1968
Bending for round square or rectangular wire up to 0.30"/0.76mm



DE-1969
for double back and triple back bands in 0.30" / .76mm & 0.36" / .91mm lingual arch wires.



DE-1970
Detailing step plier double-sided offset beak permits bayonet bends. Creates right hand or left hand step-up or stepdown at 1/2, 3/4, or 1mm increments.

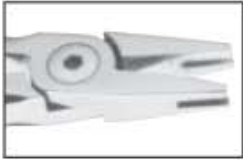

DE-1971
"V" bend stop special design makes 1mm "v" bends to shorten archwires or provide a positive stop. Excellent for placing stops in titanium wires. For round or rectangular wires up to .025"



DE-1972
Angle how plier efficient utility plier with serrated beaks for a firm grip. 45 angled tips to access hard to reach areas.



DE-1973
Weingardt plier serrated tips hold wires firmly at a convenient working angle. Tapered beaks fit easily between brackets and hard to reach areas. Our most popular utility plier.



DE-1974
Pin & Ligature Cutters TC.



DE-1975
Mini Pin & Ligature Cutter TC.



DE-1976
Standard Ligature Cutter TC.



DE-1977
V Bend Stop Plier TC.



DE-1978
Angled Direct Bond Bracket Remover TC.



DE-1979
Cutter Str.



Distal Cutter
14cm
DE-1980 2.5 mm
DE-1981 3.0 mm
DE-1982 3.0 mm

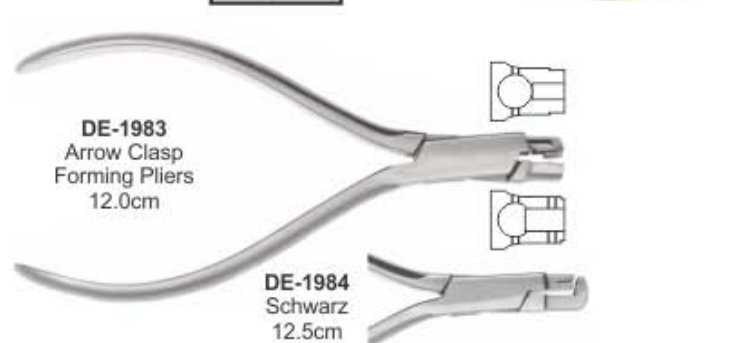

DE-1983
Arrow Clasp Forming Pliers
12.0cm

DE-1984
Schwarz
12.5cm



DE-1985
Distal end Cutter, Safety Hold Plier
(Ideal for Cutting Wire) TC.



DE-1986
Hook Crimping Plier Angled
Straight TC.



DE-1987
3 Prong Clasp Adjustable
Plier TC.



DE-1988
Utility Plier Weingart TC.



DE-1989
Direct Bracket Remover
TC.



DE-1990
Straight Direct Bond Bracket
Remover TC.



DE-1991
Pin Holding Plier TC.



DE-1992
Hard wire cutters



DE-1993
Elastic Separating Plier
Round Handle



DE-1994
Elastic
Separating Plier



DE-1995 Str.
DE-1996 Cvd.
Smaha
Elastomeric
ligature
placing forceps
140 mm



DE-1997
Elastomeric
ligature placing
forceps with
groove
Falcon 140 mm



DE-1998
Elastomeric
ligature placing
forceps with
groove
Falcon 140 mm



PLIERS FOR ORTHODONTICS & PROSTHETICS



- Щипцы для ортодонтии и протезирования
- Щипці для ортодонції та протезування
- Pincas pour l'orthodontie et la prothèse
- Alicates para ortodoncia y prótesis
- Zangen für Kieferorthopädie und Prothetik
- كاشاة لتقويم الأسنان بروستيتيس

CUTTER, UTILITY PLIERS & WIRE FORMING PLIERS



DE-1999
Weingart Pliers



DE-2004
Adhesive
Removing Pliers



DE-2000
Slim Weingart
Pliers



DE-2005
Posterior Band Removing
Pliers - Long



DE-2001
How Pliers
Straight



DE-2006
Posterior Band Removing
Pliers - Short



DE-2002
How Pliers Offset



DE-2007
Bird Beak Pliers

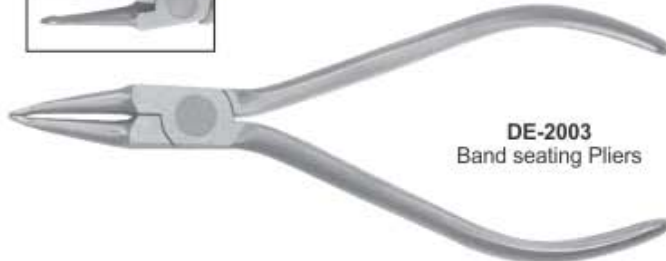

DE-2003
Band seating Pliers



Replacement tip and
hex key included.

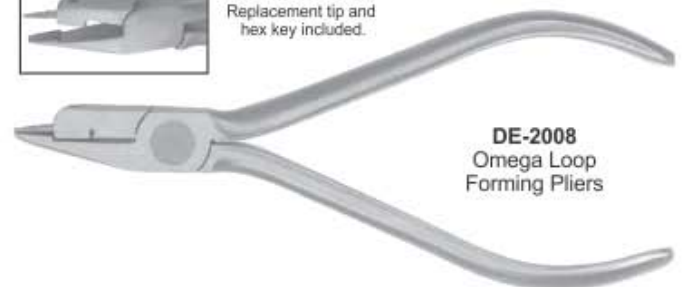

DE-2008
Omega Loop
Forming Pliers

- Щипцы для ортодонтии и протезирования
- Pincers pour l'orthodontie et la prothèse
- Zangen für Kieferorthopädie und Prothetik
- Щипці для ортодонції та протезування
- Alicates para ortodoncia y prótesis
- كاشطة لتقويم الأسنان بروستhetics

CUTTERS



DE-2009
Hard
Wire Cutter 15



DE-2013
Mini Pin &
Ligature Cutter



DE-2010
Distal End Cutter
Flush Cut



DE-2014
Hard Wire Cutter
Straight



DE-2011
Universal Cut & Hold
Distal End Cutter



DE-2015
Micro-Mini Pin &
Ligature Cutter



DE-2012
Pin & Ligature
Cutter



DE-2016
Cutter

PLIERS FOR ORTHODONTICS & PROSTHETICS



- Щипцы для ортодонтии и протезирования
- Pincas pour l'orthodontie et la prothèse
- Zangen für Kieferorthopädie und Prothetik
- Щипці для ортодонції та протезування
- Alicates para ortodoncia y prótesis
- كمانة لتقويم الأسنان بروستھتیس



DE-2017
Three Jaw Pliers



DE-2021
Jarabak Pliers



DE-2018
Light Wore Bird Beak
Pliers with Groove



DE-2022
Hollow Chop
Contouring Pliers



DE-2019
Tweed loop
Forming Pliers



DE-2023
Lingual Arch
Forming Pliers



DE-2020
Arch Bending Pliers



DE-2024
Rectangular Arch
Bending Pliers

ORTHODONTICS PLIERS STANDS

- Ортодонтия Щипцы Подставки
- Supports de pinces d'orthodontie
- Kieferorthopädie Zangenständer
- Ортодонтия Щипці Підставки
- KFO Zangen Ständer
- تقويم الأسنان كعاشة نطق



DE-2025
Plier Stand
Stainless Steel.



DE-2026
Plier Stand
Stainless Steel.



DE-2027
Pliers Stand
Stainless Rod
(Aluminum Anodized)
Stainless Steel



DE-2028
Plier Stand
Stainless Steel.



DE-2029
Plier Stand
Stainless Steel.



DE-2030
Plier Stand
Plastic

Normal Anatomy – Dental Implants

Bone Level Normal
(No Bone Loss)

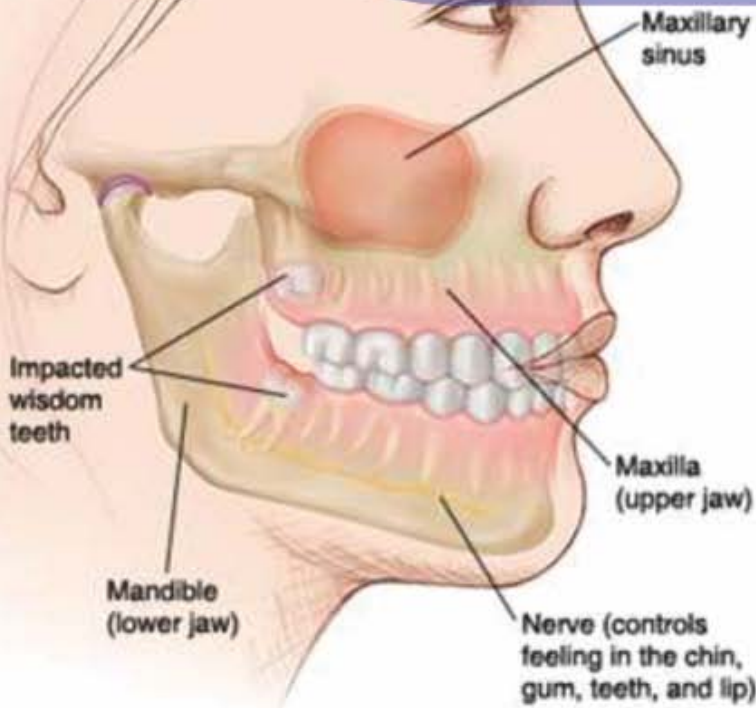
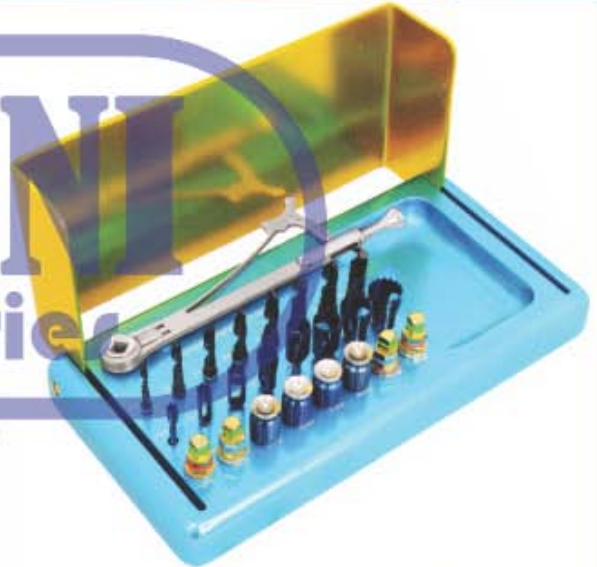
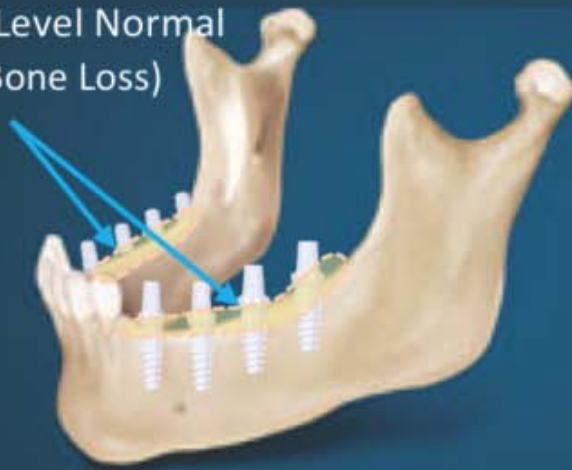

- Инструменты для имплантологии
 - Implantologie
 - Implantologie
- Инструменти для імплантології
 - Implantologia
 - زراعة الأسنان

IMPLANT GAGES



DE-2100
Multifunctional Meter
 Length 90 mm,
 different sizes,
 8-10-11mm,
 corrosion-resistant

DE-2101
Multifunctional Meter
 Length 90 mm,
 different sizes,
 5-13-15-17 mm,
 corrosion-resistant

DE-2102
Measuring Probe
 Length 170 mm,
 hand shape or flexible
 (6-8-10-14-16 mm),
 corrosion-resistant

DE-2103

DE-2104

DE-2105

DE-2106

IMPLANT GAGES



DE-2107

DE-2108

DE-2109

IMPLANTOLOGY

- Инструменты для имплантологии
- Implantologie
- Implantologie

- Инструменти для имплантології
- Implantoloia
- زراعة الأسنان



DE-2110
Ridge Mapping
Double Caliper



DE-2111
Bone Thickness Gauge
40mm, 180mm



DE-2112
Osteometer
Measuring Forceps For Jaw
Ridge Width measurement, scale
on both sides, rustfree, autoclaviv



DE-2113
Micro Boley
Gauge Twisted



DE-2114
Micro Boley
Gauge Straight



DE-2115
Ortho Ruler / Cone Socket

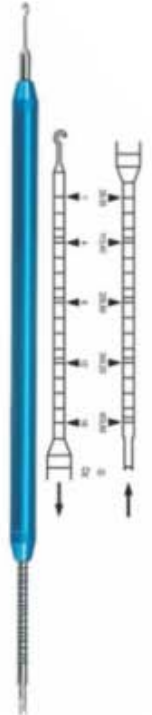

DE-2116
Dynamometer

- Инструменты для имплантологии
- Implantologie
- Implantologie
- Инструменти для імплантології
- Implantologia
- زراعة الأسنان

BLACK TITANIUM COLOUR COATED INSTRUMENTS

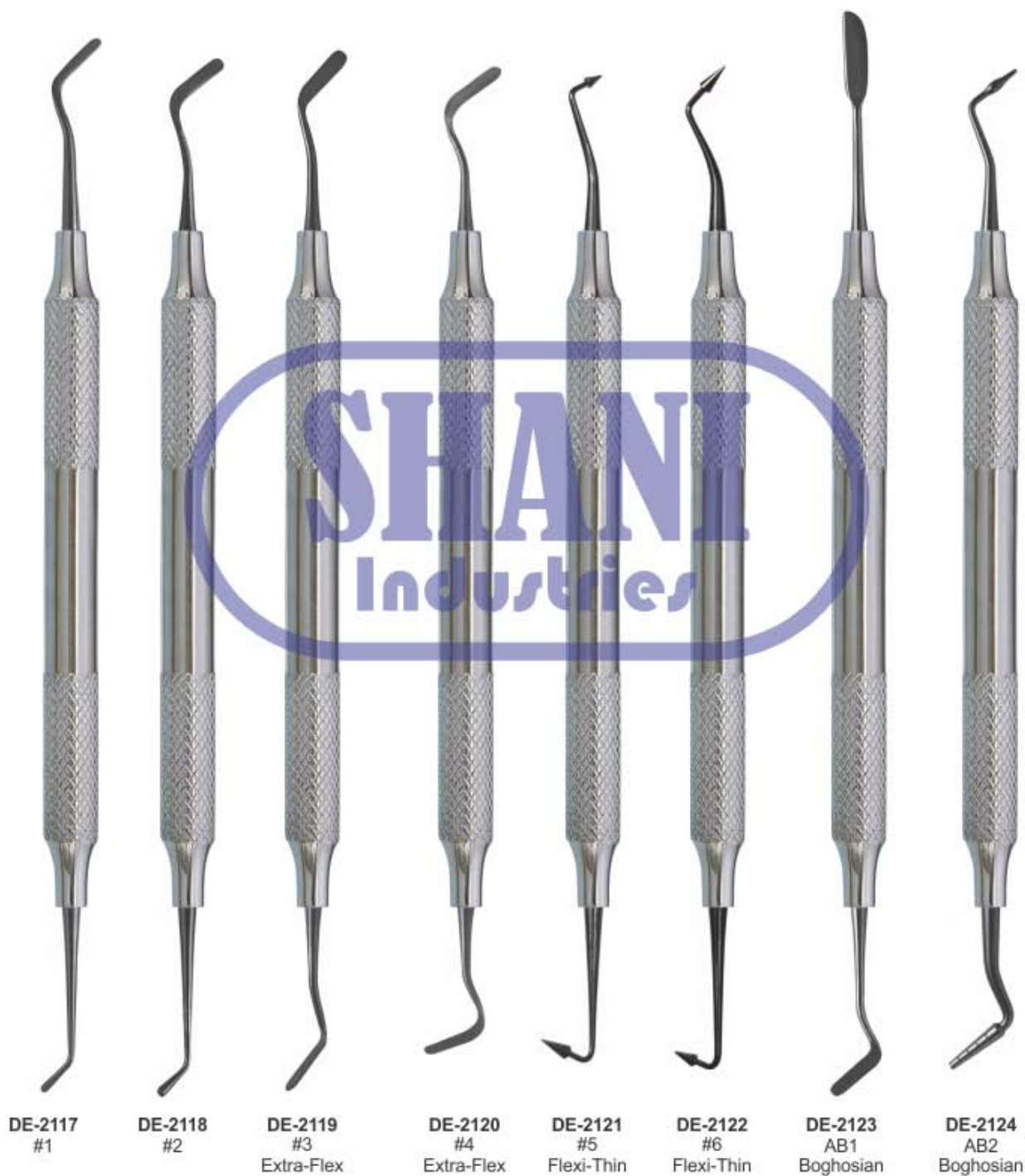

IMPLANTOLOGY



- Инструменты для имплантологии
- Implantologie
- Implantologie
- Инструменти для имплантології
- Implantoloia
- زراعة الأسنان

BLACK TITANIUM COLOUR COATED INSTRUMENTS



DE-2125
A
Cosmetic
Contouring

DE-2126
B
Cosmetic
Contouring

DE-2127
C
Cosmetic
Contouring

DE-2128
D
Cosmetic
Contouring

DE-2129
F
Cosmetic
Contouring

DE-2130
Marginal Ridge
& Embrasure
Shaping Instrument

DE-2131
Occlusal
Anatomy
Instrument

- Инструменты для имплантологии
- Implantologie
- Implantologie
- Инструменти для імплантології
- Implantologia
- زراعة الأسنان

BLACK TITANIUM COLOUR COATED INSTRUMENTS

BURNISHERS

FREEDMAN BURNISHERS

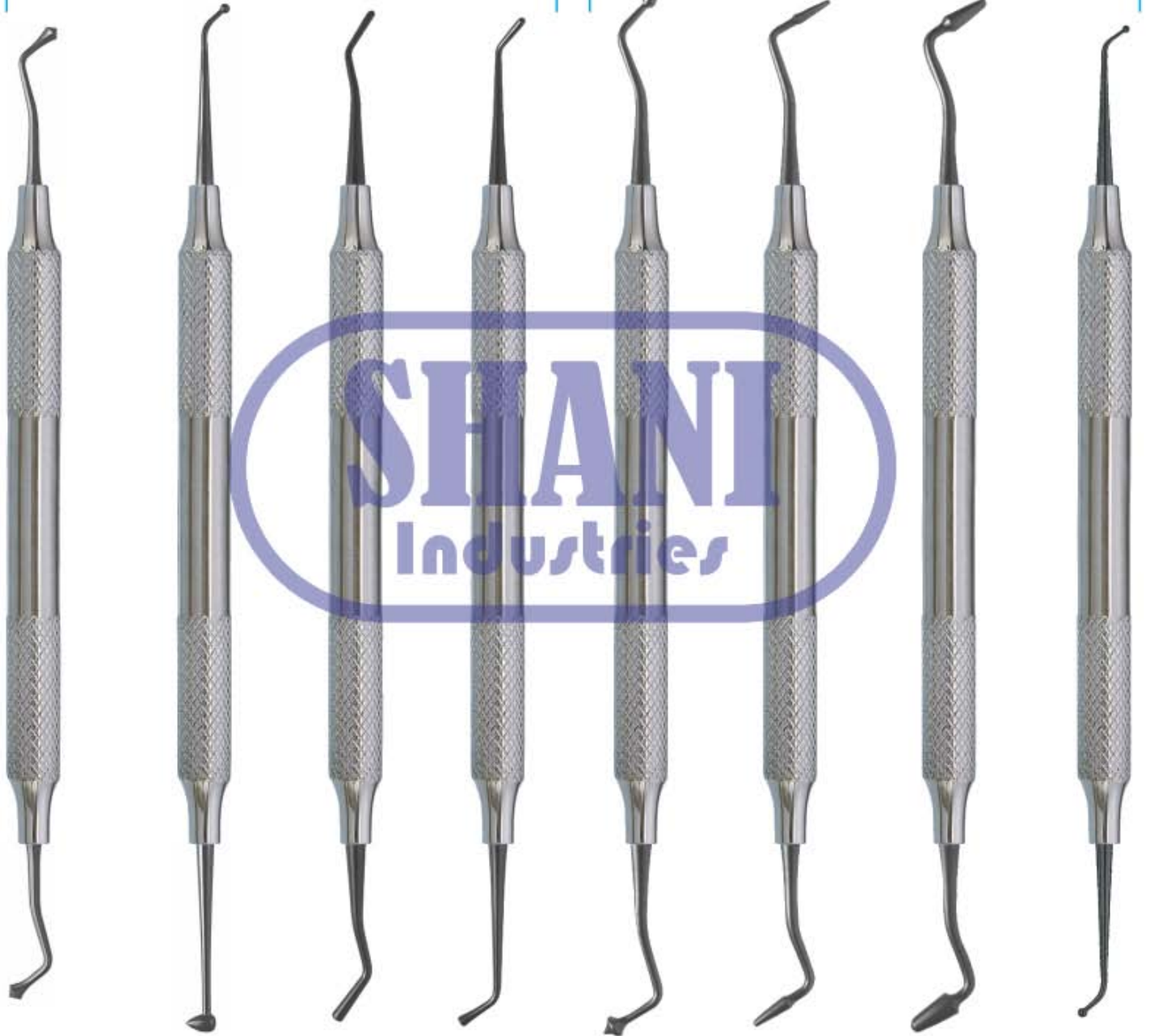

DE-2132
21B

DE-2133
27/29

DE-2134
2
Ladmore

DE-2135
3
Ladmore

DE-2136
Freedman
"Duckhead"

DE-2137
Freedman
Small Contact
Forming

DE-2138
Freedman
Large Contact
Forming

DE-2139
Small/
Medium Ball
Burnisher

IMPLANTOLOGY

- Инструменты для имплантологии
- Implantologie
- Implantologie
- Инструменти для імплантології
- Implantologia
- زراعة الأسنان

SINUS LIFT INSTRUMENTS HOLLOW HANDLE 9.5MM LENGTH 170MM

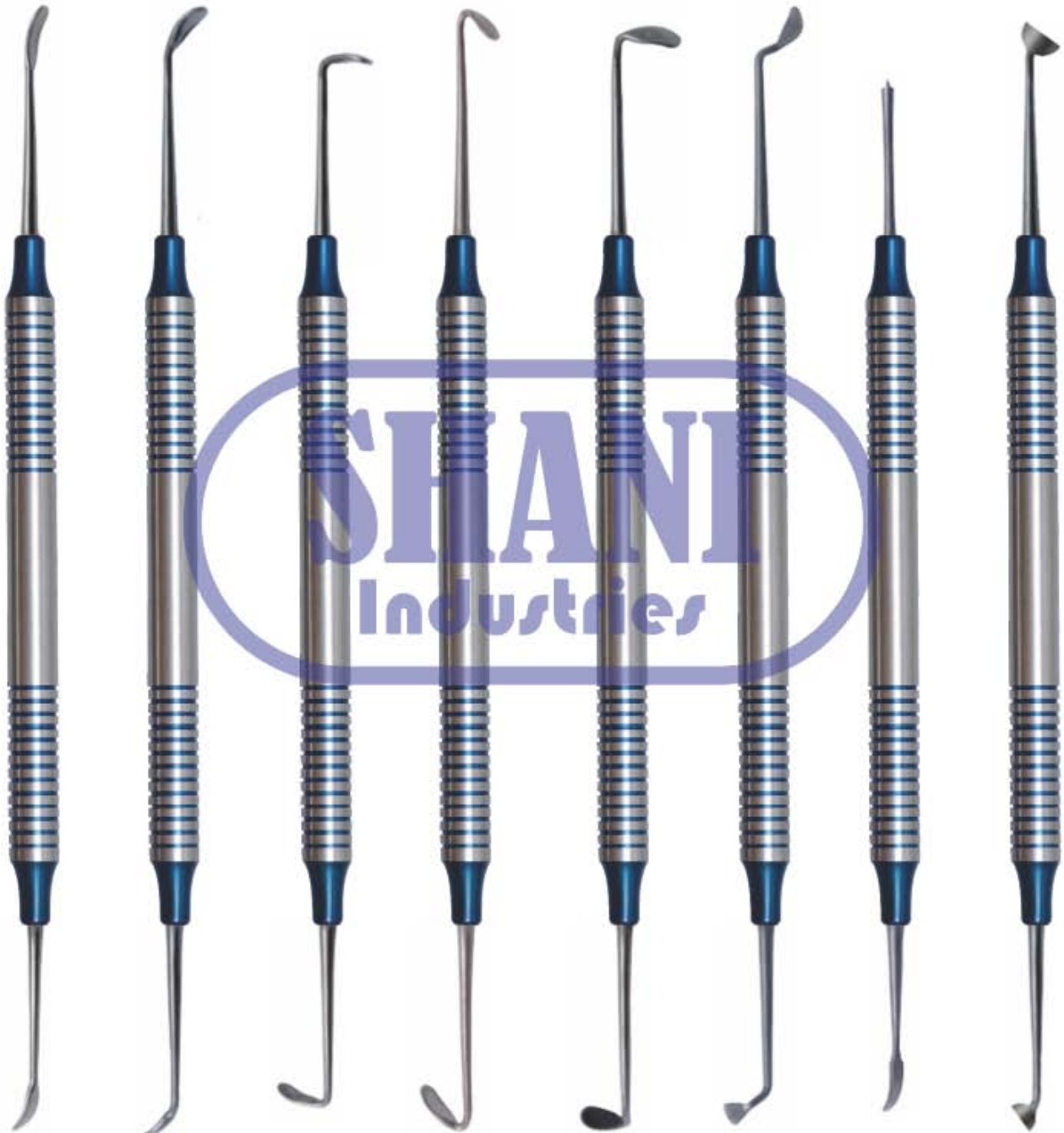

DE-2140
Sinuslift 1

DE-2141
Sinuslift 2

DE-2142
Sinuslift 3

DE-2143
Sinuslift 4

DE-2144
Sinuslift 5

DE-2145
Sinuslift 6

DE-2146
Membrane
3Positioning 1

DE-2147
Condenser 1

- Инструменты для имплантологии
- Implantologie
- Implantologie

- Инструменти для імплантології
- Implantologia
- زراعة الأسنان

Sinus Lift Instrument,
Flexible Sinus Lift instruments
reduce the risk of perforation of the
"Schneider's membrane"

Sinus Lift Elevator,
10 mm Straight grip
Length 175 mm, Sinus lift elevators, dull,
for gentle peeling and lifting the
Schneider membrane

Sinus lift instrument
10 mm Straight grip Length 180 mm,
Buser (B1, B2, B3) raspatories,
quality medical stainless steel,
corrosion-resistant



DE-2148
Fig. 1

DE-2149
Fig. 2

DE-2150
Fig. 3



DE-2151
Fig. 1

DE-2152
Fig. 2

DE-2153
Fig. 3



DE-2154
B01

DE-2155
B02

DE-2156
B03



IMPLANTOLOGY

- Инструменты для имплантологии
- Implantologie
- Implantologie

- Інструменти для імплантології
- Implantoloia
- زراعة الأسنان

Sinus lift instrument 10 mm Straight grip Sinus lift elevators, blunt or sharply curved
(H01, H02, K03, K04, K78, K77)

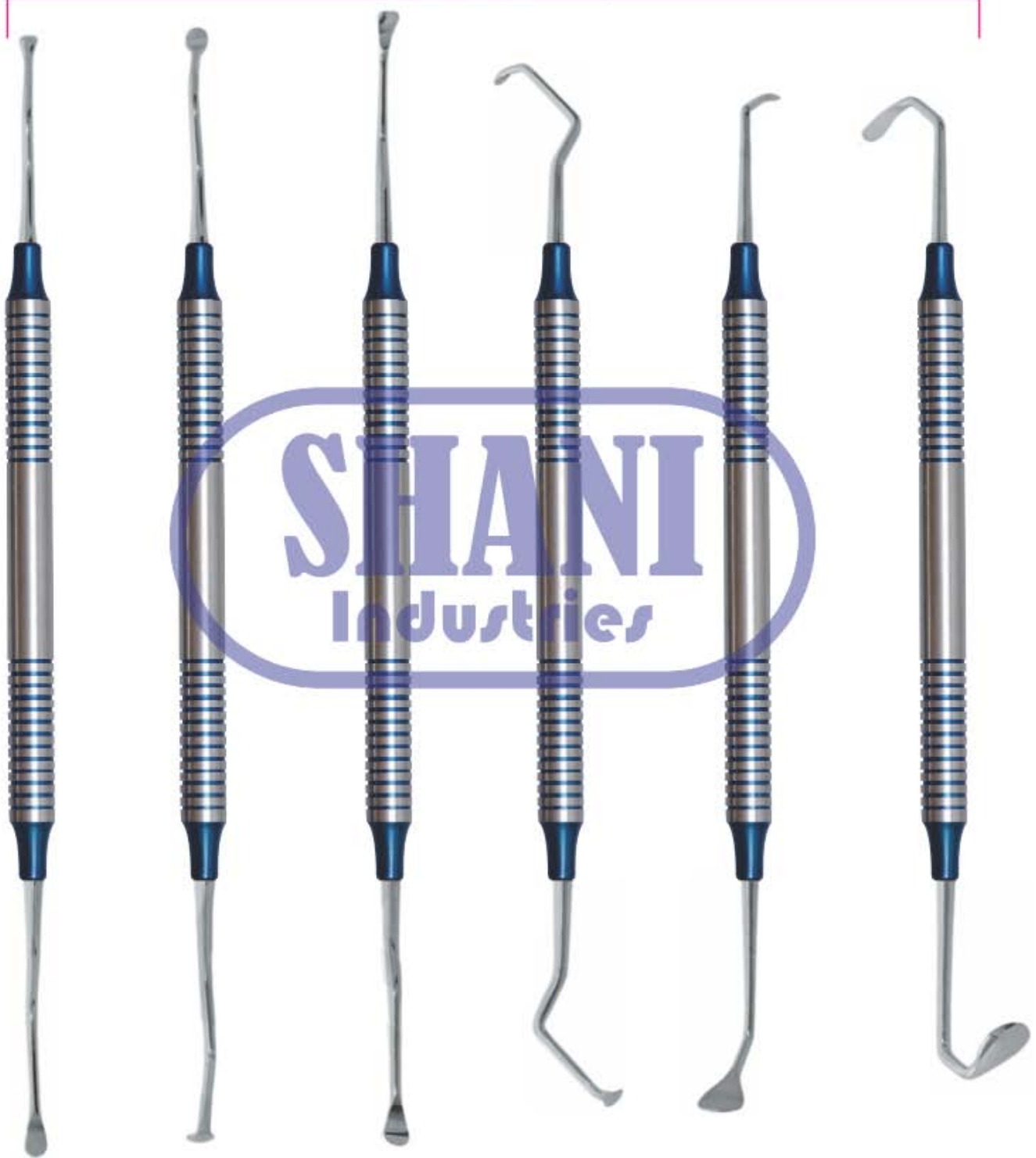

DE-2157
Sinus lift
instrument
H01

DE-2158
Sinus lift
instrument
H02

DE-2159
Sinus lift
instrument
K03

DE-2160
Sinus lift
instrument
K04

DE-2161
Sinus lift
instrument
K78

DE-2162
Sinus lift
instrument
K77

- Инструменты для имплантологии
- Имплантология
- Имплантология
- Инструменти для імплантології
- Імплантологія
- زراعة الأسنان

Composite Filling Instruments Set of 6 Pcs



DE-2163



DE-2164



DE-2165



DE-2166



DE-2167



DE-2168

COMPOSITE INSTRUMENTS USE:

A composite (tooth colored) filling is used to repair a tooth that is affected by decay, cracks, fractures, etc. The decayed or affected portion of the tooth will be removed and then filled with a composite filling.

There are many types of filling materials available, each with their own advantages and disadvantages. You and your dentist can discuss the best options for restoring your teeth. Composite fillings, along with silver amalgam fillings, are the most widely used today. Because composite fillings are tooth colored, they can be closely matched to the color of existing teeth, and are more aesthetically suited for use in front teeth or the more visible areas of the teeth.

As with most dental restorations, composite fillings are not permanent and may someday have to be replaced.

They are very durable, and will last many years, giving you a long lasting, beautiful smile.

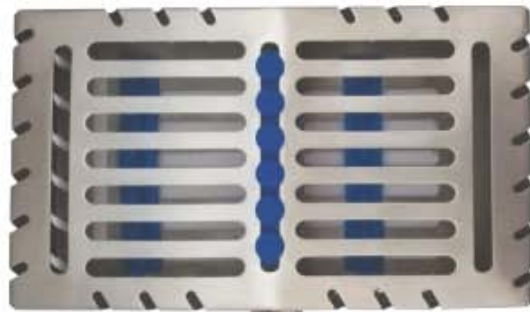

DE-2169

IMPLANTOLOGY

- Инструменты для имплантологии
- Implantologie
- Implantologie
- Инструменти для имплантології
- Implantoloia
- زراعة الأسنان

Set of 5 Composite Gold Tip Instruments
DE-2170



Set of 4 Composite Blue Tip Instruments
DE-2171



Set of 3 Composite Blue Tip Instruments
DE-2172



Set of 2 Composite Blue Tip Instruments
DE-2173



DE-2174 Periosteal Elevators Molt # 9

DE-2175 Endodontic explorer DG # 16

- Инструменты для имплантологии
- Implantologie
- Implantologie
- Инструменти для імплантології
- Implantologia
- زراعة الأسنان

VISTA TUNNELING INSTRUMENTS SET



DE-2176



DE-2177



DE-2178



DE-2179



DE-2180



DE-2181

DE-2182



IMPLANTOLOGY

- Инструменты для имплантологии
- Implantologie
- Implantologie
- Инструменти для имплантології
- Implantoloia
- زراعة الأسنان



DE-2183
used for elevation of sinus membrane



DE-2184
used for elevation of sinus membrane

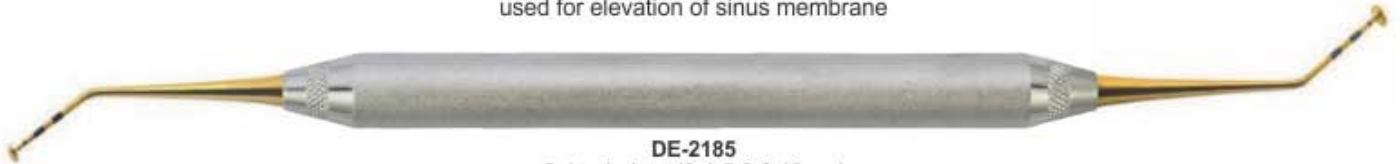

DE-2185
Cobra in / out (2-4-5-6-8-10mm)



DE-2186
Cobra 3.5mm



DE-2187
sinus 4.8 / 5.8 (2-4-5-6-8-10mm)



DE-2188
sinus 2.8 / 3.8 (2-4-5-6-8-10mm)



DE-2189
Bone Graft 3.8SP / 2.8mm (2-4-5-6-8-10mm)



DE-2190
Cobra in / out (2-4-5-6-8-10mm)



DE-2191
Cobra 3.5mm



DE-2192
Gold Color Set Dental Oral Implantology Sinus Set of 10 Pcs with cassette

- Инструменты для имплантологии
- Implantologie
- Implantologie
- Инструменти для імплантології
- Implantologia
- زراعة الأسنان



DE-2193
Sinus Lift elevator 1



DE-2194
Sinus Lift elevator 2



DE-2195
Sinus Lift elevator 3



DE-2196
Sinus Lift elevator 4



DE-2197
Sinus Lift elevator 5



DE-2198
Sinus Lift elevator 6



DE-2199
Sinus Lift Elevators Set of 7 Pcs
with cassette

IMPLANTOLOGY

- Инструменты для имплантологии
- Implantologie
- Implantologie
- Инструменти для имплантології
- Implantoloia
- زراعة الأسنان

Sinus Left Elevator Set of 10 Pcs

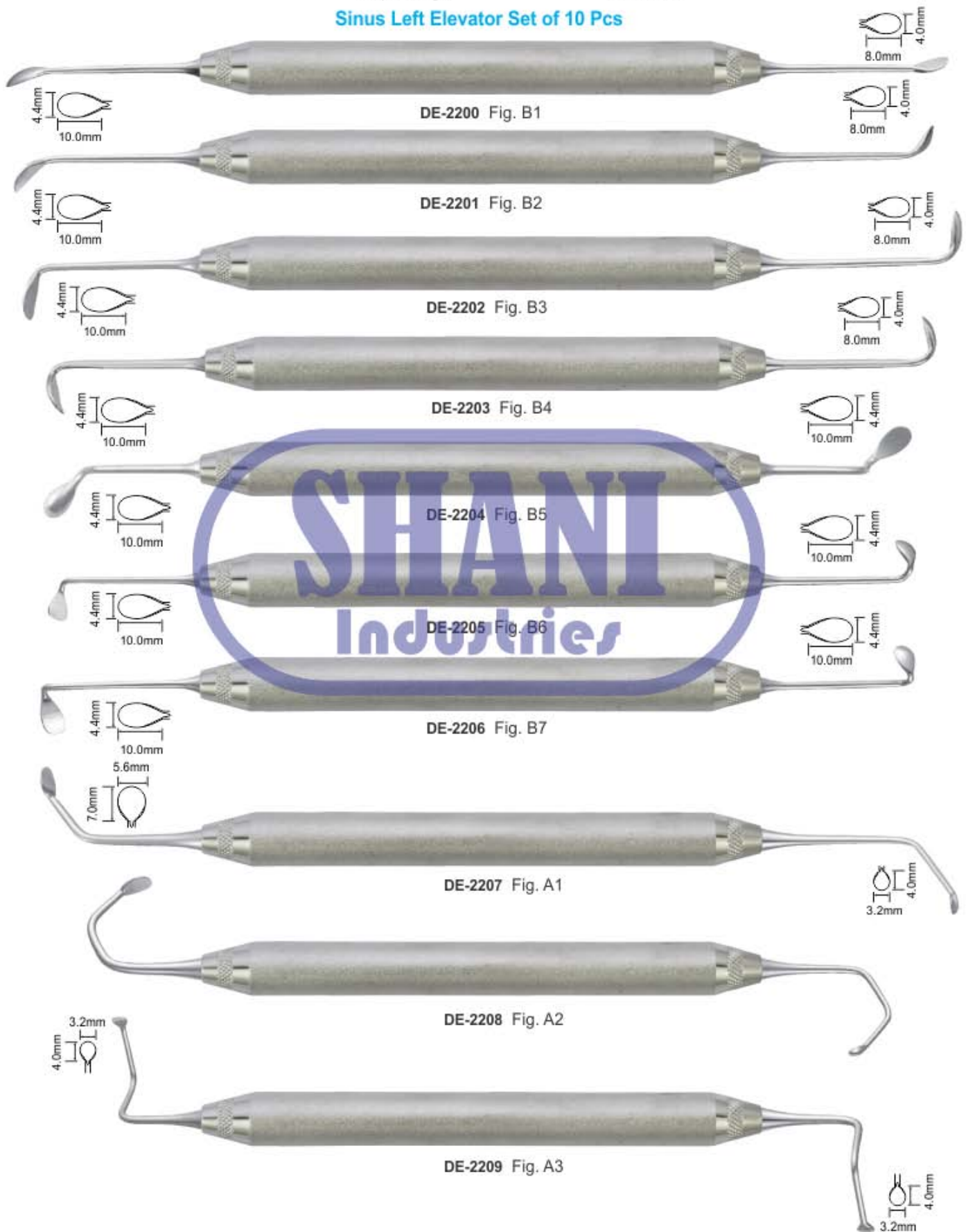

- Инструменты для имплантологии
 - Implantologie
 - Implantologie
- Инструменти для імплантології
 - Implantologia
 - زراعة الأسنان

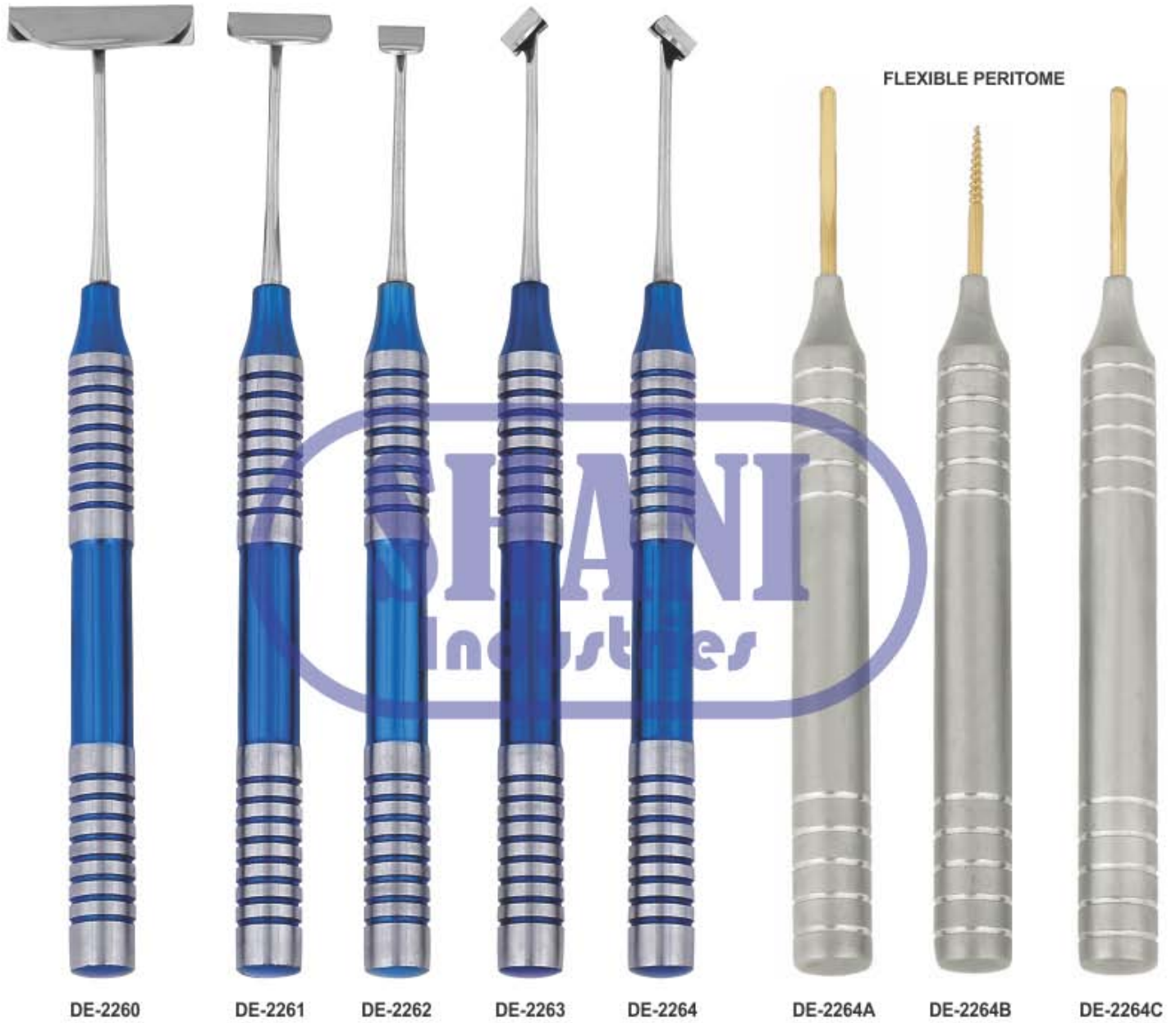

Soft Brushing Kit Set of 6 Pcs



IMPLANTOLOGY

- Инструменты для имплантологии
 - Implantologie
 - Implantologie
- Инструменти для имплантології
 - Implantoloia
 - زراعة الأسنان

SINUS ELEVATOR & MEMBRANE LIFT TIPS



DE-2265
Membrane Detach Elevator



DE-2266
Membrane Elevator



DE-2267
Membrane Elevator



DE-2268
Membrane Elevator



DE-2269
Membrane Elevator



DE-2270
Bone Graft Packer



DE-2270A Pt2 Titanium
A/V Regular



DE-2270B Pt1 Titanium
A/V Regular



DE-2270C Pt3 Titanium Angel S/E



DE-2270D Pt4 Titanium STR S/E



DE-2270E Pt5 Titanium TG CVD S/E



DE-2271
Sinus Left Elevator & Membrane Lift Tips 3
set of 7 Pcs

- Инструменты для имплантологии
- Implantologie
- Implantologie
- Инструменти для імплантології
- Implantologia
- زراعة الأسنان

MIXING SPATULA WITH SHOVEL



DE-2272
Bone Carrier
Titanium



DE-2273
Raspator, Prichard
Length 180 mm,
10 mm hollow handle,
double-ended
10.5 mm | 4.5 mm,



DE-2274
Raspator, Prichard
Length 180 mm,
10 mm hollow handle,
double ended



DE-2275
Raspator, Prichard
Length 180 mm,
10 mm hollow handle,
double-ended
10.5 mm | 4.5 mm,



DE-2276
Mixing Spatula
with shovel
17cm



DE-2277
Mixing Spatula
with shovel
18.5cm



DE-2278
Graft Material Spoon
Concave Tip For
Larger Grafts

IMPLANTOLOGY

- Инструменты для имплантологии
 - Implantologie
 - Implantologie
- Инструменти для имплантології
 - Implantoloia
 - زراعة الأسنان

BONE GRAFTING INSTRUMENTS COMPACTOR /TAMPERS

Product offering includes instruments for harvesting, mixing and compacting bone Provides clinicians with the proper instrumentation for bone grafting procedures Weighted bone basin Prevents tipping and spilling of bone and other materials during mixing



DE-2279
Graft Packer, Concave Tips DE 4/6mm



DE-2280
Bone Spoon/ Packer DE 3mm



DE-2281
Blade and pusher Length 180 mm, for straight or angled, blade: 15 x 5 mm, pusher: 4 mm diameter Straight



DE-2282
Blade and pusher Length 180 mm, for straight or angled, blade: 15 x 5 mm, pusher: 4 mm diameter angular



DE-2283
Spoon and pusher Length 180 mm, for angled spoon: 10 x 5 mm, pusher: diameter 3 mm



DE-2284
Graft Packer, Smooth Tips DE 5/8mm



DE-2285
Graft Packer, Serrated Tips DE 3/4mm



DE-2286
Graft Packer, Serrated Tips DE 6/8mm



DE-2287
Titanium graft packer/placement site depth gauge 3.3mm & 4.0mm Diameter tips Marked at 8, 11, 13, 15 & 18mm



DE-2288
Tamper Length 170 mm, for bone material, double-ended, diameter 3.2 mm (2-4-6-8-10) and diameter 2.5mm (2-4-6-8-10)

- Инструменты для имплантологии
- Implantologie
- Implantologie
- Инструменти для імплантології
- Implantologia
- زراعة الأسنان

SPOON AND PUSHER (TRINOVO)

Trinovo handle, different workers, for bone material, high-grade medical stainless steel, corrosion-resistant



DE-2289
10x5mm

Spoon and Pusher
with safety stop

DE-2290
10x5mm

Spoon and Pusher
with safety stop

DE-2291
10x5mm

Spoon and Pusher
with safety stop

DE-2292
Bone Graft/Carrier
Titanium
2-4-6-8-10mm

DE-2293
15x10mm

Spoon and Pusher
with safety stop

DE-2294
10x5mm

Spoon and Pusher
with safety stop

DE-2295
10x5mm

Spoon and Pusher
with safety stop

IMPLANTOLOGY



- Инструменты для имплантологии
- Implantologie
- Implantologie

- Инструменти для імплантології
- Implantoloia
- زراعة الأسنان

Hollow Handle 10mm Length 170mm



- Инструменты для имплантологии
- Implantologie
- Implantologie
- Инструменти для имплантології
- Implantoloia
- زراعة الأسنان

TISSUE MEMBRANE FORCEPS



DE-2305
Tissue Graft Forcep
Serrated Teeth



DE-2306
Self Locking
Grooved



DE-2307
Tissue Graft Forcep
Serrated Teeth



DE-2308
Titanium
Locking Plier



DE-2309
TC Gripper Carbide
Tipped Tissue Forceps
Serrated Carbide Tips
14.5cm



DE-2310
Adson Carbide
Tipped Tissue Forceps
Serrated Carbide Tips
12cm



DE-2311
Micor Adson 1x2
Tissue Forcep 12.1cm
1x2 Teeth - 0.5mm Tips



DE-2312
Adson 7x7
Tissue Forceps
7x7 Teeth 12cm



DE-2313
Adson 7x7 Curved
Tissue Forceps
7x7 Teeth 12cm



DE-2314
Suture Pliers
Suture Forceps with
1.6mm Ring Tip



DE-2315
Debaquey Atraumatic
Tissue Forceps Straight
Serrated Teeth
16cm



DE-2316
Debaquey Atraumatic
Tissue Forceps Curved
Serrated Teeth
16cm



IMPLANTOLOGY

- Инструменты для имплантологии
 - Implantologie
 - Implantologie
- Инструменти для имплантології
 - Implantologia
 - زراعة الأسنان

TISSUE MEMBRANE FORCEPS



DE-2317
Russian Long
Tissue Forceps
Serrated Tip
20cm



DE-2318
Russian
Tissue Forceps
Serrated Tip
15cm



DE-2319
Tissue Punch Forceps
To Remove Tissue
After Using Punch



DE-2320
13.5 cm
narrow



DE-2321
10.5 cm
Membrane tweezers KUEHNE



DE-2322
13.5 cm
wide



DE-2323
Pin-Tweezers
with or without lock,
length 15 cm,
with lock



DE-2324
without lock



DE-2325
Haltepinzette with lock
15,5 cm, for pins, towards
the tips, etc



DE-2326
Carry Forceps
15cm



DE-2327
Carry Forceps
15cm



DE-2328
Carry Forceps
15cm

- Инструменты для имплантологии
- Implantologie
- Implantologie
- Инструменти для имплантології
- Implantologia
- زراعة الأسنان

OSTEOTOME CONVEXES / CONCAVE / CONIQUES

CONVEXES



DE-2329
SET OF 5 PIECES

CONCAVES

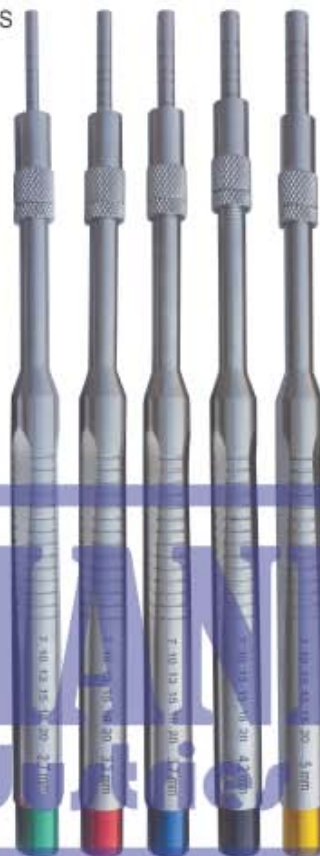

DE-2330
SET OF 5 PIECES

CONIQUES



DE-2331
SET OF 5 PIECES

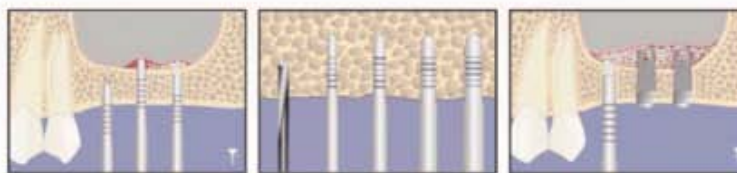

	CONVEXES STRAIGHT	DE-2329	2,7 Ømm	3,2 Ømm	3,7 Ømm	4,2 Ømm	5 Ømm
	CONCAVES STRAIGHT	DE-2330	2,7 Ømm	3,2 Ømm	3,7 Ømm	4,2 Ømm	5 Ømm
	CONIQUES STRAIGHT	DE-2331	2,7 Ømm	3,2 Ømm	3,7 Ømm	4,2 Ømm	5 Ømm

IMPLANTOLOGY

- Инструменты для имплантологии
- Implantologie
- Implantologia
- زراعة الأسنان

OSTEOTOME CONVEXES / CONCAVE / CONIQUES

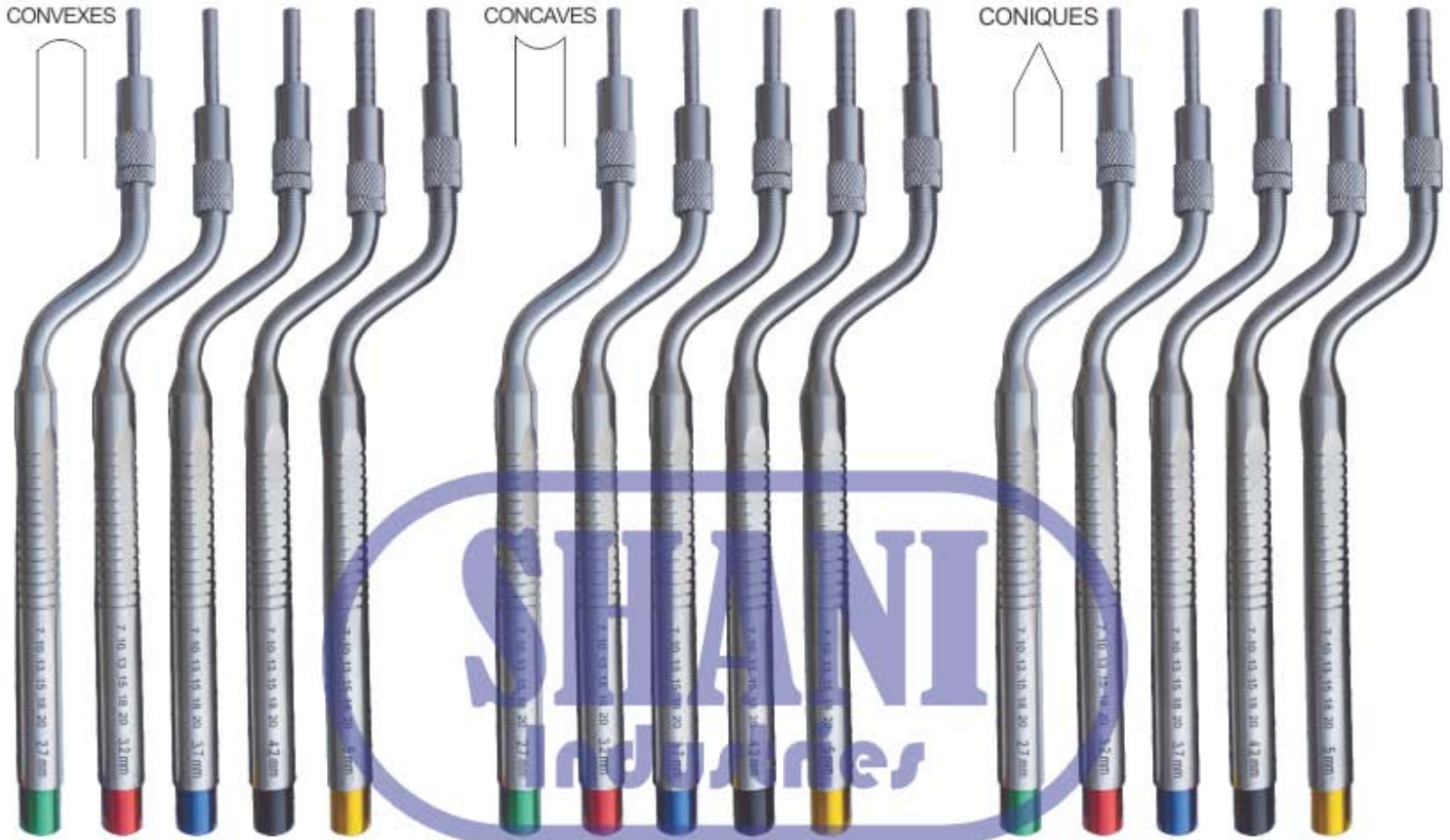

DE-2332
SET OF 5 PIECES

DE-2333
SET OF 5 PIECES

DE-2334
SET OF 5 PIECES

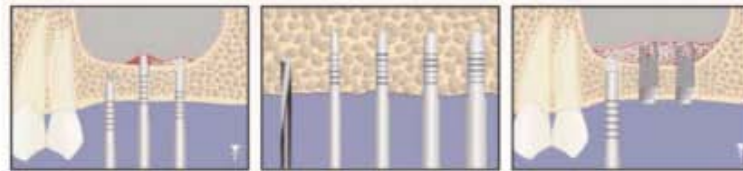

	CONVEXES CURVED	DE-2332	2,7 Ømm	3,2 Ømm	3,7 Ømm	4,2 Ømm	5 Ømm
	CONCAVES CURVED	DE-2333	2,7 Ømm	3,2 Ømm	3,7 Ømm	4,2 Ømm	5 Ømm
	CONIQUES CURVED	DE-2334	2,7 Ømm	3,2 Ømm	3,7 Ømm	4,2 Ømm	5 Ømm

STERILIZING MESH TRAY

Different sizes & dimensions are available at buyer's demand



MESH TRAYS
DE-2825
Different sizes & dimensions are available at buyer's demand



MESH TRAYS
DE-2826
05 Pcs



MESH TRAYS
DE-2827
07 Pcs



MESH TRAYS
DE-2828
10 Pcs



MESH TRAYS
DE-2829
20 Pcs

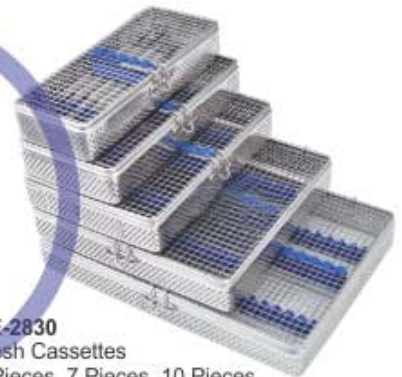

DE-2830
Mesh Cassettes
5 Pieces, 7 Pieces, 10 Pieces,
15 Pieces & 20 Pieces



MESH TRAY
DE-2831 240x130x50mm
DE-2832 240x130x60mm
DE-2833 240x250x50mm
DE-2834 240x250x60mm
DE-2835 480x250x50mm
DE-2836 480x250x60mm
DE-2837 480x250x70mm



MESH TRAY
DE-2838 240x250x 50mm
DE-2839 240x250x 60mm
DE-2840 240x250x 70mm
DE-2841 480x250x 50mm
DE-2842 480x250x 60mm
DE-2843 480x250x 70mm
DE-2844 480x250x100mm



MESH TRAY
DE-2845 240x250x50mm
DE-2846 240x250x60mm
DE-2847 240x250x70mm
DE-2848 280x250x50mm
DE-2849 280x250x60mm



MESH TRAY
DE-2850 280x250x 70mm
DE-2851 280x250x100mm
DE-2852 280x250x 50mm
DE-2853 280x280x 60mm
DE-2854 280x280x 70mm
DE-2855 300x280x 60mm

- Инструменты для имплантологии
 - Implantologie
 - Implantologie
- Инструменти для імплантології
 - Implantologia
 - زراعة الأسنان

BONE SCRAPER STRAIGHT & CURVED



DE-2335
Bone Scraper
Straight

DE-2336
Bone Scraper
Curved

TISSUE PUNCH STRAIGHT & CURVED

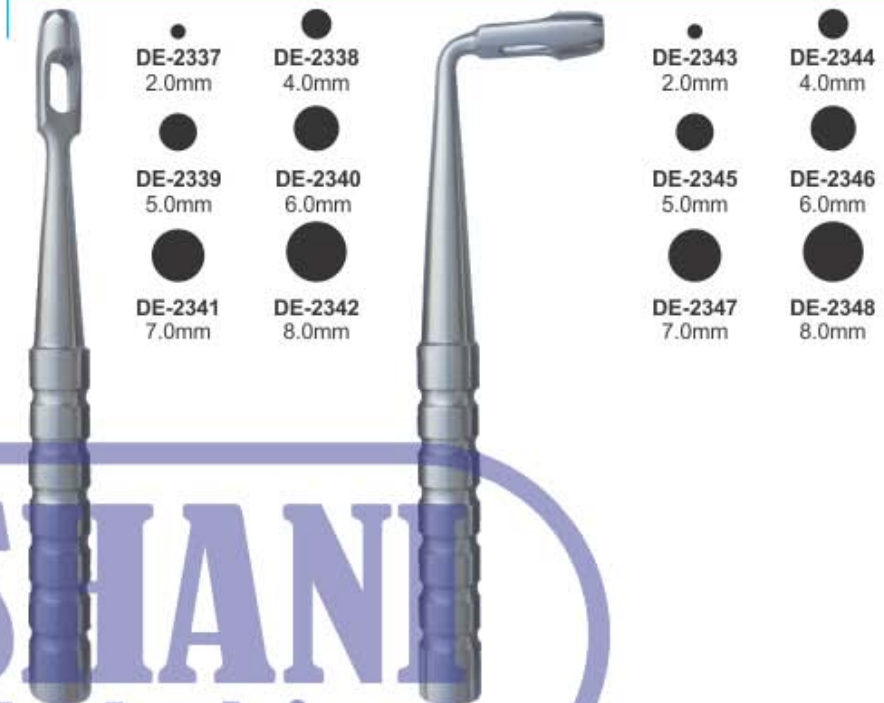

Tissue Punch
Straight

Tissue Punch
Curved

Ø4.0 Ø5.0 Ø6.0 Ø7.0



DE-2349
Tissue Punch with pin
Set of Four Pieces



DE-2350
Tissue Punch
Set of Five Pieces



DE-2351
Tissue Punch
Set of Five Pieces

IMPLANTOLOGY

- Инструменты для имплантологии
- Implantologie
- Implantologie
- Инструменти для имплантології
- Implantoloia
- زراعة الأسنان

BONE MILL BONE WELL

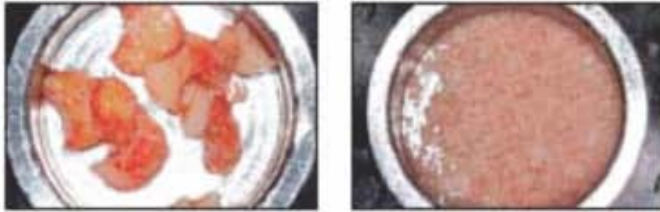

DE-2352
BONE CRUSHER
Titanium Metal Cutter

mallet



DE-2356
Gold Mill (Small)



BONE CRUSHER
DE-2353

DE-2354
Bone Mill

DE-2355
Basins For Bone



DE-2357
Gold mill (Large)

- Инструменты для имплантологии
 - Implantologie
 - Implantologie
- Инструменти для імплантології
 - Implantologia
 - زراعة الأسنان

TREPINE

Burs with depth markings are suited for precise and simple transplantation of cylindrical bone grafts as well as for all other bone-extraction tasks.



DE-2358 Ø Int. 2 mm Ø Ext. 3 mm	DE-2359 Ø Int. 3 mm Ø Ext. 3.5 mm	DE-2360 Ø Int. 4 mm Ø Ext. 5 mm	DE-2361 Ø Int. 5 mm Ø Ext. 6 mm	DE-2362 Ø Int. 6 mm Ø Ext. 7 mm	DE-2363 Ø Int. 7 mm Ø Ext. 8 mm	DE-2364 Ø Int. 8 mm Ø Ext. 9 mm	DE-2365 Ø Int. 9 mm Ø Ext. 10 mm	DE-2366 Ø Int. 10 mm Ø Ext. 11 mm
--	--	--	--	--	--	--	---	--



DE-2367
Trephine Drill
Set of Eight Pieces

DE-2368
Trephine Drill
Set of Eight Pieces

BONE INJECTORS, COLLECTORS & SUCTION TUBE



DE-2369 Ø 2.5mm / 3.5mm 170mm	DE-2370 Ø 4.5mm / 5.5mm 170mm	DE-2371 Ø 3.5mm / 4.5mm 170mm	DE-2372 Ø 6.0mm / 7.0mm 170mm	DE-2373 18cm Straight / Bend I.D 2.5mm O.D 3.5	DE-2374 18cm Straight / Bend I.D 3.5mm O.D 4.5	DE-2375 18cm Straight / Bend I.D 4.5mm O.D 5.5	DE-2376 18cm Straight / Bend I.D 6.0mm O.D 7.0
---	---	---	---	---	---	---	---

IMPLANTOLOGY

- Инструменты для имплантологии
 - Implantologie
 - Implantologie
- Инструменти для имплантології
 - Implantoloia
 - زراعة الأسنان

BONE EXPANDER SCREW & SURGICAL KITS



Ø2.0mm Ø2.5mm Ø2.8mm
DE-2377 Short Implant Drills

Ø3.2mm Ø3.65mm Ø4.2mm Ø5.2mm
DE-2378 Long Implant Drills



DE-2379 Bone Universal Kit
 Drill: 2mm, 2.8mm, 3.2mm, 3.65mm, 4.2mm, 4.5mm, 4.8mm, 5.2mm
 Trepines Bit: 3.0mm, 4.0mm, 5.0mm, 6.0mm, 7.0mm, 8.0mm, 9.0mm, 10mm
 Driver: 2.5mm, 2.5mm Hand Pcs, 1.25mm, 1.25mm Hand Pcs
 Short Driver 2.5mm, Long Driver 2.5mm
 1.25mm, Short Hex Driver Hand Pcs
 1.25mm, Long Hex Driver Hand Pcs, Torque Wrench 4.0mm



DE-2380 Bone Expander Kit
 Expander: 2.6mm, 3.0mm, 3.4mm, 3.8mm, 4.3mm
 Ratchet Driver, Parallel Pin
 Pilot Drill, Drill 1.4mm, Drill Driver 4mm
 Hand Driver 4mm, Ratchet 4.0mm



DE-2381 Bone Universal Kit
 Drill: 2mm, 2.8mm, 3.2mm, 3.65mm, 4.2mm, 4.5mm, 4.8mm, 5.2mm
 Trepines Bit: 3.0mm, 4.0mm, 5.0mm, 6.0mm, 7.0mm, 8.0mm, 9.0mm, 10mm.
 Bone Compression: 2mm, 3.3mm, 2.8mm, 4.2mm, 3mm, 3.5mm
 Driver: 2.5mm, 2.5mm Hand Pcs
 1.25mm, 1.25mm Hand Pcs
 Short Driver 2.5mm
 Long Driver 2.5mm
 1.25mm, Short Hex Driver Hand Pcs
 1.25mm, Long Hex Driver Hand Pcs
 Torque Wrench 6.35mm 1 Pcs



DE-2382
 Conical Drills: 20 Pcs
 Tissue Punches: 3.0mm, 3.50mm, 4.0mm, 4.5mm, 5.0mm, 6.0mm, 6.50mm
 Bone Expander: 1.6/3.8mm, 1.9/3.0mm, 2.1/3.6mm, 2.6/3.8mm, 2.9/4.3mm
 Drill Adapter: 1 Pcs
 1.25mm, 2.50mm Hex Driver Hand Pcs
 Pilot Drill: 1.6mm
 Drill Bit: 1.4mm, 1.6mm, 1.8mm, 2.0mm, 2.2mm
 Ratchet Driver: 4mm/6.35, 1.25/2.50
 Rimer: 3.2/4.7mm, 3.7/4.7mm
 Parallel Pin: 4.5mm, 2.5mm
 Double step Drill: 2.4/2.8mm
 Depth Gauge: 1 Pcs
 Torque Wrench 6.35mm Universal: 1 Pcs

- Инструменты для имплантологии
 - Implantologie
 - Implantologie
- Инструменти для імплантології
 - Implantologia
 - زراعة الأسنان

KEYS FOR IMPLANT SCREW



DE-2383



DE-2384



DE-2385



DE-2386

TORQUE WRENCH & RATCHET



DE-2387 Star Torque Wrench 6.35mm Universal



DE-2393 Star Torque Wrench 6.35mm Universal



DE-2399 Star Ratchet Wrench 6.35mm Universal



DE-2388 Round Torque Wrench 4.0mm Universal



DE-2394 Star Torque Wrench 6.35mm Universal



DE-2400 Star Ratchet Wrench 4.0mm Universal



DE-2389 Hex Driver With 4.0mm Driver



DE-2395 Star Torque Wrench 6.35mm Universal



DE-2401 Round Ratchet Wrench 4.0mm Universal



DE-2390 Star Torque Wrench 6.35mm Universal



DE-2396 Star Torque Wrench 6.35mm Universal



DE-2402 Round Ratchet Wrench 3.35mm Universal



DE-2391 Hex Torque Wrench 4.00mm Universal



DE-2397 Star Ratchet Wrench 6.35mm Universal



DE-2403 Star Ratchet Wrench 4.0mm Universal



DE-2392 Star Torque Wrench 6.35mm Universal



DE-2398 Star Ratchet Wrench 6.35mm Universal



DE-2404 Star Ratchet Wrench 6.35mm Universal

IMPLANTOLOGY

- Инструменты для имплантологии
- Implantologie
- Implantsologie
- Инструменти для імплантології
- Implantologia
- زراعة الأسنان



DE-2405
Suction Cannula Kit
with 3 Needles



Suction Pipe



Suction Needle
1mm



Suction Needle
1.5mm



Suction Needle
2mm



2cm

2.7cm

With Filter

DE-2406
17.5cm

DE-2407
18cm

DE-2408
coarse
Ø 5mm
Suction tubes to collect
the extracted
bone material
180mm



DE-2409
fine
Ø 9mm

1.5mm 3mm 5mm



DE-2410
Suction
Tubes
180mm

DE-2411
Suction
Tubes
180mm

DE-2412
Suction
Tubes
180mm



DE-2414
Ø 3 mm
length 180mm
DE-2415
Ø 4 mm
length 180mm
DE-2416
Ø 5 mm
length 180mm

DE-2413
Fig. 6FR
Frazier
15 cm - Ø 2 mm

IMPRESSION TRAYS

- Оттисные ложки
- Porte-empreinte
- Abdrucklöffel
- Відбиткові ложки
- Cubetas para impresiones
- صواني الانطباع

PERFORATED WITH RIM LOCK

Set of 06 Pcs



DE-2417 SET OF 06 PCS

Upper: S, M, L
Lower: S, M, L

PERFORATED WITH RIM LOCK

Set of 8 Pcs

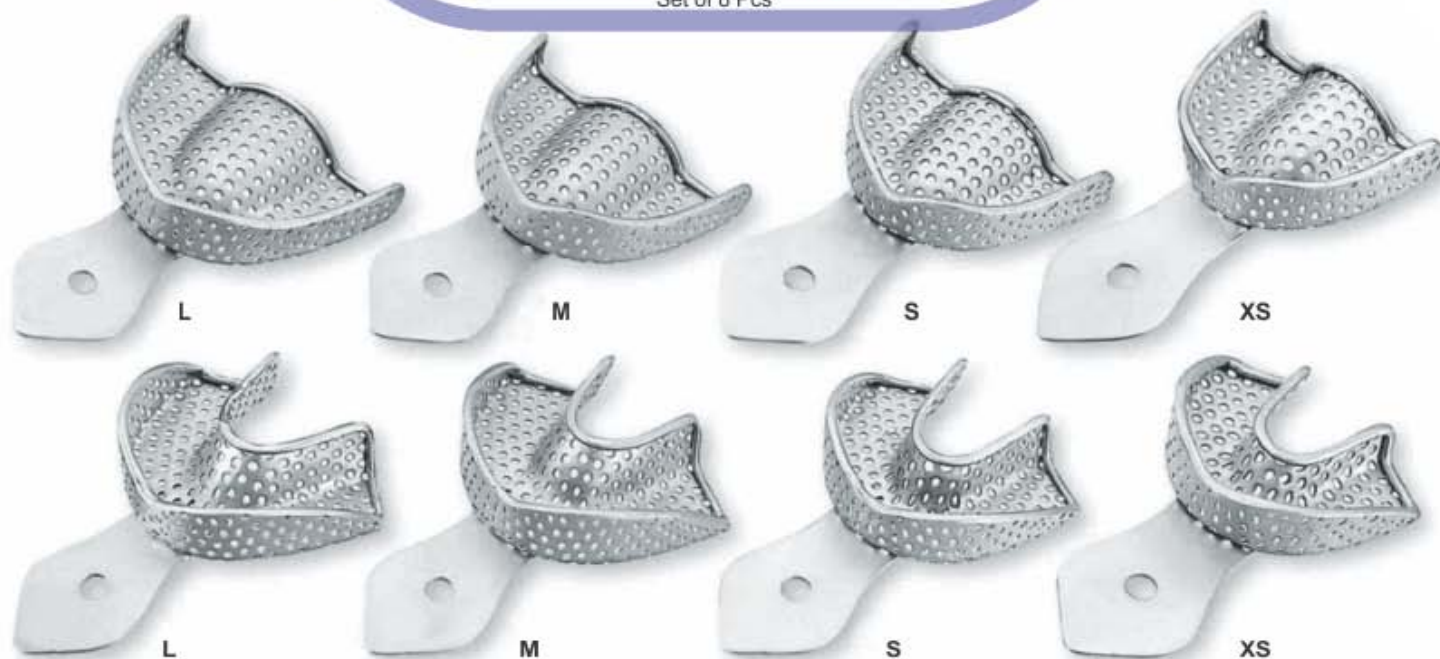

DE-2418 SET OF 08 PCS

Upper: XS, S, M, L
Lower: XS, S, M, L

DE-2419 SET OF 08 PCS

Upper: S, M, L, XL
Lower: S, M, L, XL

DE-2420 SET OF 10 PCS

Upper: XS, S, M, L, XL
Lower: XS, S, M, L, XL

IMPRESSION TRAYS

- Оттисные ложки
- Porte-empreinte
- Abdrucklöffel

- Відбиткові ложки
- Cubetas para impresiones
- صواني الانطباع

SOLID WITH RIM LOCK

Set of 6 Pcs



DE-2421 SET OF 06 PCS
Upper: S, M, L
Lower: S, M, L

SHANI
Industries

SOLID WITH RIM LOCK

Set of 8 Pcs



DE-2422 SET OF 08 PCS
Upper: XS, S, M, L
Lower: XS, S, M, L

DE-2423 SET OF 08 PCS
Upper: S, M, L, XL
Lower: S, M, L, XL

DE-2424 SET OF 10 PCS
Upper: XS, S, M, L, XL
Lower: XS, S, M, L, XL

IMPRESSION TRAYS

- Оттисные ложки
 - Porte-empreinte
 - Abdrucklöffel
- Відбиткові ложки
 - Cubetas para impresiones
 - صواني الانطباع

PERFORATED FULL DENTURE

Set of 8 Pcs



DE-2425 SET OF 08 PCS
Upper: S, M, L, XL
Lower: S, M, L, XL

DE-2426 SET OF 08 PCS
Upper: S, M, L
Lower: S, M, L

SOLID FULL DENTURE

Set of 8 Pcs

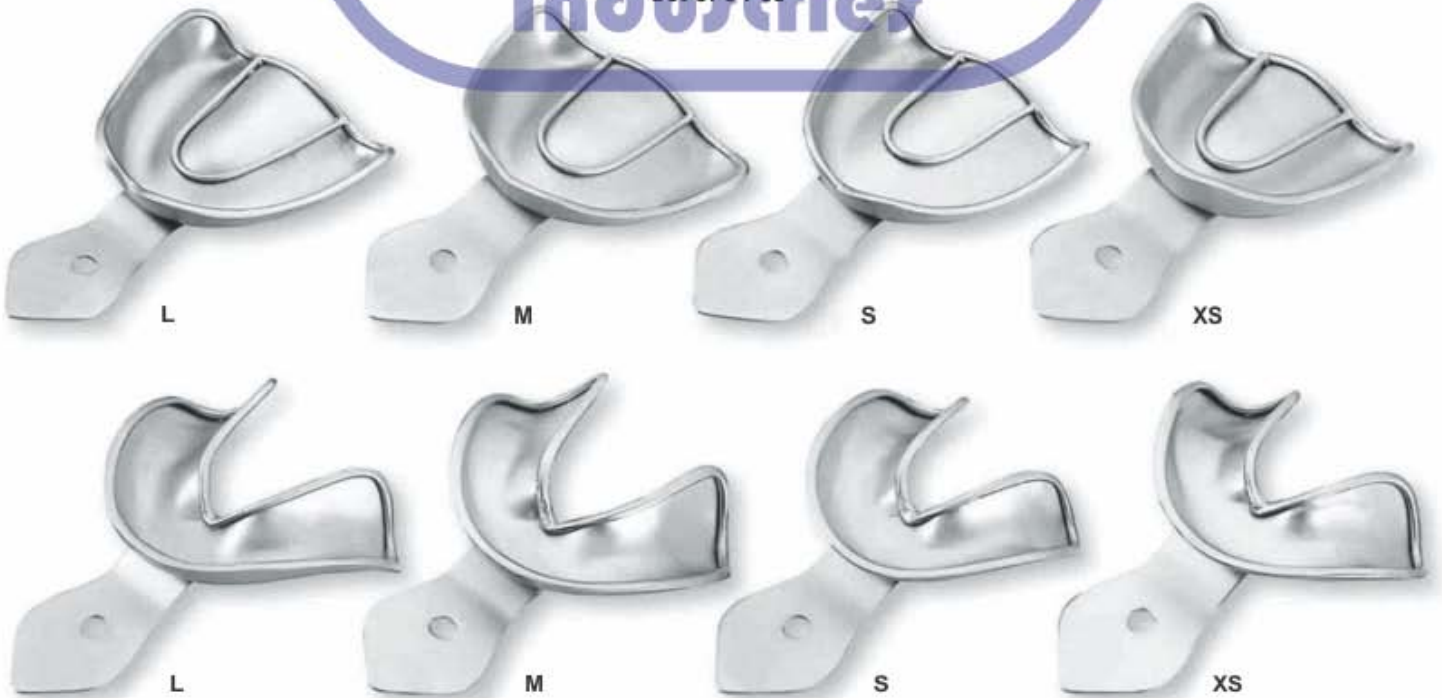

DE-2427 SET OF 08 PCS
Upper: S, M, L, XL
Lower: S, M, L, XL

DE-2428 SET OF 06 PCS
Upper: S, M, L
Lower: S, M, L

IMPRESSION TRAYS

- Оттисные ложки
 - Porte-empreinte
 - Abdrucklöffel
- Відбиткові ложки
 - Cubetas para impresiones
 - صواني الانطباع

Perforated Without Rim Lock



Solid With Rim Lock

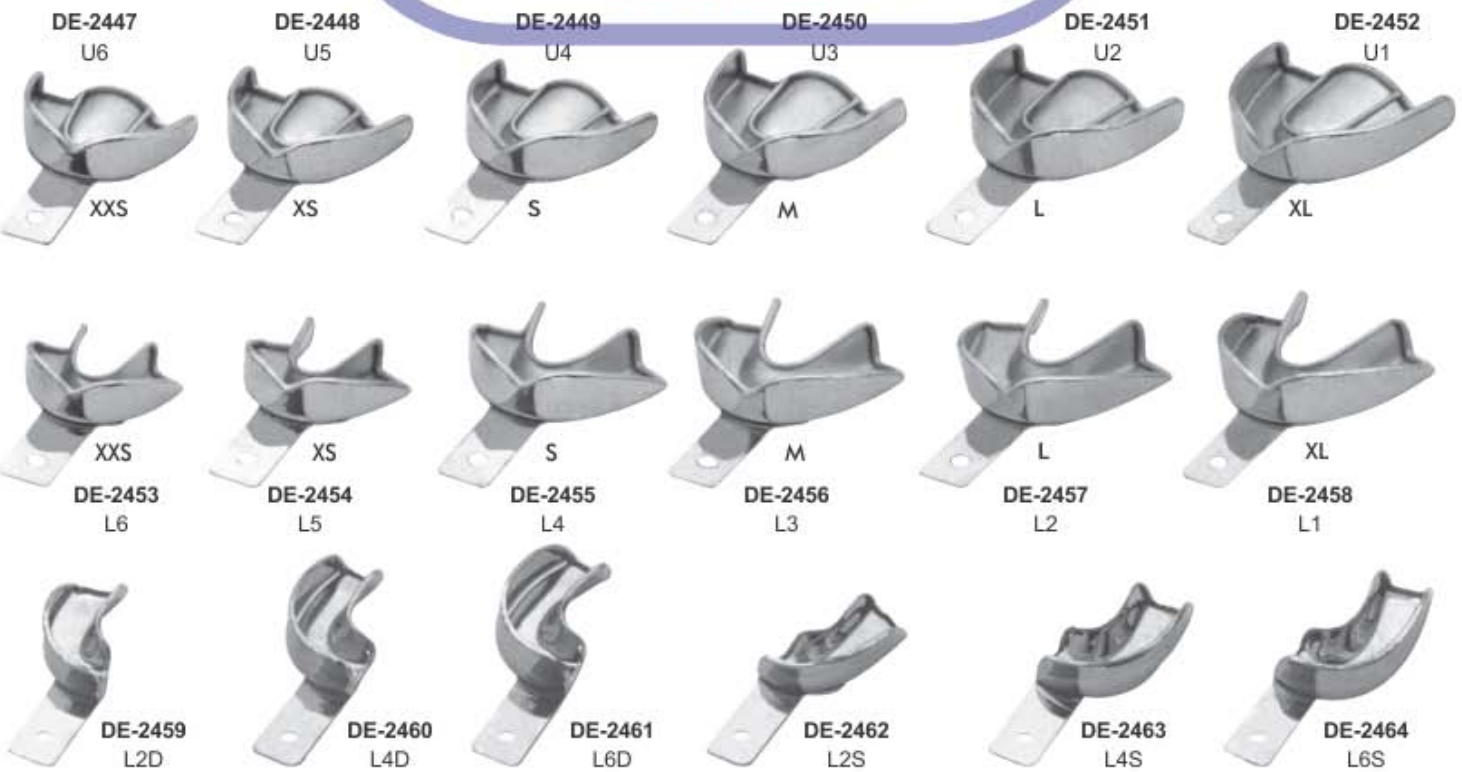



SHANI
Industries





Scalers Tray
DE-2500 200 x 100 mm



Scalers Trays
DE-2501 205 x 115 x 17 mm
DE-2502 205 x 152 x 17 mm
DE-2503 290 x 115 x 17 mm



Instruments Trays
DE-2504 200 x 110 x 30 mm
DE-2505 215 x 115 x 35 mm
DE-2506 220 x 130 x 30 mm
DE-2507 230 x 125 x 35 mm
DE-2508 245 x 140 x 40 mm
DE-2509 285 x 160 x 45 mm
DE-2510 315 x 175 x 50 mm
DE-2511 330 x 185 x 50 mm



Instruments Trays
DE-2512 150 x 100 x 50 mm
DE-2513 200 x 100 x 50 mm
DE-2514 220 x 120 x 50 mm
DE-2515 240 x 140 x 50 mm
DE-2516 200 x 150 x 50 mm
DE-2517 250 x 200 x 50 mm
DE-2518 300 x 250 x 50 mm
DE-2519 300 x 200 x 50 mm
DE-2520 350 x 250 x 50 mm
DE-2521 400 x 300 x 50 mm
DE-2522 450 x 300 x 50 mm
DE-2523 450 x 350 x 50 mm



Instruments Trays With Lid
DE-2524 150 x 100 x 50 mm
DE-2525 200 x 100 x 50 mm
DE-2526 220 x 120 x 50 mm
DE-2527 240 x 140 x 50 mm
DE-2528 200 x 150 x 50 mm
DE-2529 250 x 200 x 50 mm
DE-2530 300 x 250 x 50 mm
DE-2531 300 x 200 x 50 mm
DE-2532 350 x 250 x 50 mm
DE-2533 400 x 300 x 50 mm
DE-2534 450 x 300 x 50 mm
DE-2535 450 x 350 x 50 mm



Mayo Tray Perforated
DE-2536 150 x 100 x 25 mm
DE-2537 200 x 100 x 25 mm
DE-2538 220 x 120 x 25 mm
DE-2539 240 x 140 x 25 mm
DE-2540 200 x 150 x 25 mm
DE-2541 250 x 200 x 25 mm
DE-2542 300 x 250 x 25 mm
DE-2543 300 x 200 x 25 mm
DE-2544 350 x 250 x 25 mm
DE-2545 400 x 300 x 25 mm
DE-2546 450 x 300 x 25 mm
DE-2547 450 x 350 x 25 mm



Scaler Tray
DE-2548 200 x 115 mm
DE-2549 205 x 150 mm
DE-2550 290 x 150 mm
DE-2551 300 x 200 mm



Instruments Tray Perforated
DE-2552 150 x 100 x 50 mm
DE-2553 200 x 100 x 50 mm
DE-2554 220 x 120 x 50 mm
DE-2555 240 x 140 x 50 mm
DE-2556 200 x 150 x 50 mm
DE-2557 250 x 200 x 50 mm
DE-2558 300 x 250 x 50 mm
DE-2559 300 x 200 x 50 mm
DE-2560 350 x 250 x 50 mm
DE-2561 400 x 300 x 50 mm
DE-2562 450 x 300 x 50 mm
DE-2563 450 x 350 x 50 mm

Sterilizing boxes & instruments Trays



Instruments Box with Hooks

- DE-2564 170 x 70 x 30 mm
- DE-2565 180 x 80 x 40 mm
- DE-2566 200 x 100 x 40 mm
- DE-2567 200 x 100 x 50 mm
- DE-2568 220 x 120 x 50 mm
- DE-2569 250 x 150 x 50 mm
- DE-2570 250 x 200 x 50 mm
- DE-2571 300 x 150 x 60 mm
- DE-2572 300 x 200 x 50 mm
- DE-2573 350 x 250 x 50 mm
- DE-2574 400 x 200 x 100 mm
- DE-2575 450 x 250 x 50 mm



Instruments Box

- DE-2576 170 x 70 x 30 mm
- DE-2577 180 x 80 x 40 mm
- DE-2578 200 x 100 x 40 mm
- DE-2579 200 x 100 x 50 mm
- DE-2580 220 x 120 x 50 mm
- DE-2581 250 x 150 x 50 mm
- DE-2582 250 x 200 x 50 mm
- DE-2583 300 x 150 x 60 mm
- DE-2584 300 x 200 x 50 mm
- DE-2585 350 x 250 x 50 mm
- DE-2586 400 x 200 x 100 mm
- DE-2587 450 x 250 x 50 mm



Instruments Box Perforated

- DE-2588 170 x 70 x 30 mm
- DE-2589 180 x 80 x 40 mm
- DE-2590 200 x 100 x 40 mm
- DE-2591 200 x 100 x 50 mm
- DE-2592 220 x 120 x 50 mm
- DE-2593 250 x 150 x 50 mm
- DE-2594 250 x 200 x 50 mm
- DE-2595 300 x 150 x 60 mm
- DE-2596 300 x 200 x 50 mm
- DE-2597 350 x 250 x 50 mm
- DE-2598 400 x 200 x 100 mm
- DE-2599 450 x 250 x 50 mm



Gloves Box
DE-2600 300 x 150 mm



Catheters Tray with lid

- DE-2601 200 x 60 x 40 mm
- DE-2602 200 x 90 x 40 mm
- DE-2603 320 x 95 x 50 mm
- DE-2604 328 x 90 x 50 mm
- DE-2605 365 x 90 x 50 mm
- DE-2606 440 x 115 x 50 mm



Box With Filter
DE-2607 100 x 50 mm
DE-2608 250 x 150 mm
DE-2609 150 x 65 mm
DE-2610 200 x 100 mm
DE-2611 300 x 200 mm



Instruments Trays With Cover

- DE-2612 210 x 110 x 50 mm
- DE-2613 240 x 160 x 50 mm
- DE-2614 300 x 180 x 50 mm
- DE-2615 360 x 210 x 50 mm
- DE-2616 400 x 230 x 55 mm

Instruments Trays Without Cover

- DE-2617 210 x 110 x 50 mm
- DE-2618 240 x 160 x 50 mm
- DE-2619 300 x 180 x 50 mm
- DE-2620 360 x 210 x 50 mm
- DE-2621 400 x 230 x 55 mm



Instruments Box with lid

- DE-2622 170 x 70 x 30 mm
- DE-2623 180 x 80 x 40 mm
- DE-2624 200 x 100 x 40 mm
- DE-2625 200 x 100 x 50 mm
- DE-2626 220 x 120 x 50 mm
- DE-2627 250 x 150 x 50 mm
- DE-2628 250 x 200 x 50 mm
- DE-2629 300 x 150 x 60 mm
- DE-2630 300 x 200 x 50 mm
- DE-2631 350 x 250 x 50 mm
- DE-2632 400 x 200 x 100 mm
- DE-2633 450 x 250 x 50 mm



Kidney Tray
 DE-2634 160 mm
 DE-2635 200 mm
 DE-2636 250 mm
 DE-2637 280 mm
 DE-2638 300 mm



Kidney Tray Shallow
 DE-2639 170 mm
 DE-2640 220 mm
 DE-2641 240 mm



Kidney Tray With Cover
 DE-2642 160 mm
 DE-2643 200 mm
 DE-2644 250 mm
 DE-2645 280 mm
 DE-2646 300 mm



Kidney Tray
 DE-2647 160 mm
 DE-2648 200 mm
 DE-2649 250 mm
 DE-2650 280 mm
 DE-2651 300 mm



Forceps Jars
 DE-2652 30 x 90 mm
 DE-2653 50 x 100 mm
 DE-2654 50 x 130 mm
 DE-2655 50 x 175 mm
 DE-2656 75 x 100 mm
 DE-2657 75 x 130 mm
 DE-2658 75 x 175 mm
 DE-2659 100 x 175 mm
 DE-2660 100 x 200 mm



Methot Jar Without Lid
 DE-2661



Dressing Jar / Cotton Container
 DE-2662 80 x 80 mm
 DE-2663 100 x 60 mm
 DE-2664 100 x 80 mm
 DE-2665 100 x 100 mm
 DE-2666 120 x 80 mm
 DE-2667 120 x 100 mm
 DE-2668 150 x 100 mm
 DE-2669 150 x 150 mm
 DE-2670 180 x 150 mm
 DE-2671 180 x 180 mm
 DE-2672 200 x 200 mm
 DE-2673 240 x 240 mm



Sputum Cup
 DE-2674



Dressing Jar With Lid & Knob
 DE-2675 80 x 80 mm
 DE-2676 90 x 90 mm
 DE-2677 100 x 100 mm
 DE-2678 120 x 120 mm
 DE-2679 100 x 130 mm
 DE-2680 150 x 150 mm
 DE-2681 125 x 170 mm



Round Bowls
 DE-2682 80 x 35 mm
 DE-2683 125 x 60 mm



Spirit Lamp
DE-2684



Spirit Lamp
DE-2685



Spirit Lamp
DE-2686



Cotton Holding Jar
DE-2687



Cotton Holder
DE-2688

Cotton Holder
DE-2689



Cotton Wool Dispenser Acc. to Methot
DE-2690



Needle Sterilization Tub
DE-2691



Round Endodontic Boxes
complete with lid
DE-2692 Ø mm. 94 - h. mm. 70



Endodontic Box
DE-2693

HOLLOWWARE INSTRUMENTS



DE-2694
100 x 180 x 11mm
Mini size



DE-2695
100 x 180 x 11mm
Mini size



DE-2696
100 x 180 x 11mm
Mini size



DE-2697
100 x 180 x 11mm
Mini size



DE-2698
100 x 180 x 11mm
Mini size



Lid
Coperchio

DE-2699
103 x 182 x 10mm
Mini size



DE-2700
Silver



DE-2701 Blue
DE-2702 Red



DE-2703 Blue
DE-2704 Red



DE-2705
Silver



DE-2706
Green



DE-2708
Blue



DE-2707
Golden



DE-2709
Red



DE-2710
Silver



DE-2711
Midi
125 x 105 x 54mm



DE-2712
Maxi
204 x 105 x 54mm

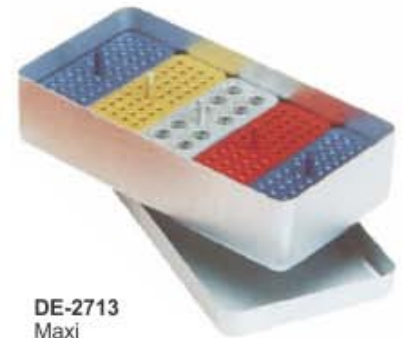

DE-2713
Maxi
204 x 105 x 54mm



Round Sterilizer Drum

DE-2714	mm. Ø 80 x 80 H
DE-2715	mm. Ø 125 x 80 H
DE-2716	mm. Ø 125 x 100 H
DE-2717	mm. Ø 125 x 125 H
DE-2718	mm. Ø 150 x 80 H
DE-2719	mm. Ø 150 x 100 H
DE-2720	mm. Ø 150 x 130 H
DE-2721	mm. Ø 150 x 150 H
DE-2722	mm. Ø 150 x 190 H
DE-2723	mm. Ø 190 x 125 H
DE-2724	mm. Ø 190 x 145 H
DE-2725	mm. Ø 190 x 165 H
DE-2726	mm. Ø 190 x 190 H
DE-2727	mm. Ø 190 x 240 H
DE-2728	mm. Ø 190 x 290 H
DE-2729	mm. Ø 240 x 120 H
DE-2730	mm. Ø 240 x 145 H
DE-2731	mm. Ø 240 x 165 H
DE-2732	mm. Ø 240 x 190 H
DE-2733	mm. Ø 240 x 240 H
DE-2734	mm. Ø 240 x 290 H
DE-2735	mm. Ø 240 x 340 H
DE-2736	mm. Ø 240 x 390 H
DE-2737	mm. Ø 290 x 145 H
DE-2738	mm. Ø 290 x 165 H
DE-2739	mm. Ø 290 x 190 H
DE-2740	mm. Ø 290 x 240 H
DE-2741	mm. Ø 290 x 290 H
DE-2742	mm. Ø 290 x 340 H
DE-2743	mm. Ø 290 x 390 H
DE-2744	mm. Ø 340 x 145 H
DE-2745	mm. Ø 340 x 165 H
DE-2746	mm. Ø 340 x 190 H
DE-2747	mm. Ø 340 x 240 H
DE-2748	mm. Ø 340 x 290 H
DE-2749	mm. Ø 340 x 340 H
DE-2750	mm. Ø 340 x 390 H
DE-2751	mm. Ø 390 x 140 H
DE-2752	mm. Ø 390 x 165 H
DE-2753	mm. Ø 390 x 190 H
DE-2754	mm. Ø 390 x 240 H
DE-2755	mm. Ø 390 x 290 H
DE-2756	mm. Ø 390 x 340 H
DE-2757	mm. Ø 390 x 390 H
DE-2758	mm. Ø 390 x 490 H

Round Sterilizer Drums "Filter"

DE-2759	mm. Ø 80 x 80 H
DE-2760	mm. Ø 125 x 80 H
DE-2761	mm. Ø 125 x 100 H
DE-2762	mm. Ø 125 x 125 H
DE-2763	mm. Ø 150 x 100 H
DE-2764	mm. Ø 150 x 130 H
DE-2765	mm. Ø 150 x 150 H
DE-2766	mm. Ø 150 x 190 H
DE-2767	mm. Ø 190 x 145 H
DE-2768	mm. Ø 190 x 165 H
DE-2769	mm. Ø 190 x 190 H
DE-2770	mm. Ø 190 x 240 H
DE-2771	mm. Ø 240 x 145 H
DE-2772	mm. Ø 240 x 165 H
DE-2773	mm. Ø 240 x 190 H
DE-2774	mm. Ø 240 x 240 H
DE-2775	mm. Ø 240 x 290 H
DE-2776	mm. Ø 240 x 340 H
DE-2777	mm. Ø 240 x 390 H
DE-2778	mm. Ø 290 x 145 H
DE-2779	mm. Ø 290 x 165 H
DE-2780	mm. Ø 290 x 190 H
DE-2781	mm. Ø 290 x 240 H
DE-2782	mm. Ø 290 x 290 H
DE-2783	mm. Ø 290 x 340 H
DE-2784	mm. Ø 290 x 390 H
DE-2785	mm. Ø 340 x 145 H
DE-2786	mm. Ø 340 x 165 H
DE-2787	mm. Ø 340 x 190 H
DE-2788	mm. Ø 340 x 240 H
DE-2789	mm. Ø 340 x 290 H
DE-2790	mm. Ø 390 x 140 H
DE-2791	mm. Ø 390 x 165 H
DE-2792	mm. Ø 390 x 190 H
DE-2793	mm. Ø 390 x 240 H
DE-2794	mm. Ø 390 x 290 H
DE-2795	mm. Ø 390 x 340 H
DE-2796	mm. Ø 390 x 490 H

Round Bowls With Cover

DE-2797	Ø 40 mm ml.30
DE-2798	Ø 60 mm ml.50
DE-2799	Ø 80 mm ml.150
DE-2800	Ø 100 mm ml.250
DE-2801	Ø 120 mm ml.450
DE-2802	Ø 150 mm ml.750
DE-2803	Ø 180 mm ml.1500
DE-2804	Ø 200 mm ml.2100
DE-2805	Ø 250 mm ml.3500

Round Bowls With Out Cover

DE-2806	Ø 40 mm ml.30
DE-2807	Ø 60 mm ml.50
DE-2808	Ø 80 mm ml.150
DE-2809	Ø 100 mm ml.250
DE-2810	Ø 120 mm ml.450
DE-2811	Ø 150 mm ml.750
DE-2812	Ø 180 mm ml.1500
DE-2813	Ø 200 mm ml.2100
DE-2814	Ø 250 mm ml.3500

INSTRUMENTS MANAGEMENT SYSTEM

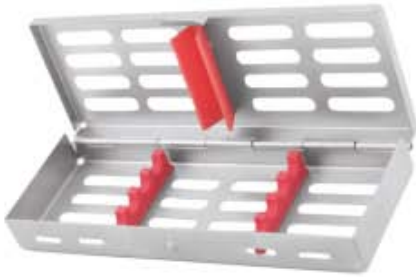

Cassette For 4 Instruments
DE-2815



Cassette For 5 Instruments
DE-2816



Cassette For 6 Instruments
DE-2817



Cassette For 7 Instruments
DE-2818

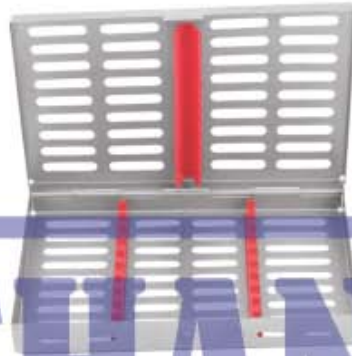

Cassette For 10 Instruments
DE-2819



Cassette For 20 Instruments
DE-2820



Cassette For Extraction Forceps
DE-2821

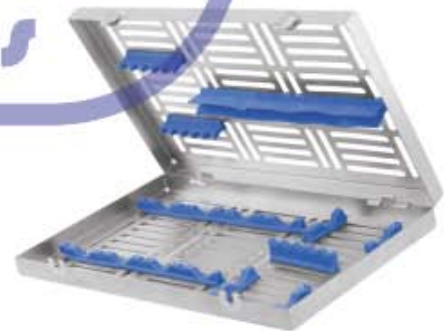

Cassette For Root Elevator
DE-2822



DE-2823
Cassette Tray
15 Pcs



DE-2824
Cassette Tray
15 Pcs

HOLLOWWARE INSTRUMENTS



DE-2856
18×7×3.5cm
5 Instruments Cassette
Detachable Lids
+
5 Instruments Cassette Hinged
Lids with button Lock



DE-2857
29×18.5×3.5cm
20 Instruments Cassette Hinged
Lids with surgical kit fitting,
button lock



Instruments Cassette
DE-2858 5 Pieces Cassette
DE-2859 7 Pieces Cassette
DE-2860 10 Pieces Cassette



DE-2861
18×11×3.5cm
Extra large cassette for 6
Instruments, with compartment
for small parts hinged lids



DE-2862
29×18.5×3.5cm
20 Instruments Cassette
Detachable Lids
+
20 Instruments Cassette Hinged
Lids with button Lock

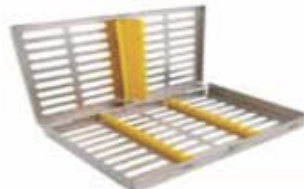

DE-2863
10×13×2.2cm
10 Instruments Cassette Hinged
Lids, Click Lock Available in 2
designs



DE-2864
29×18.5×3.5cm
20 Instruments Cassette Detachable
Lids with elevator fitting
+
20 Instruments Cassette Hinged
Lids with elevator fitting , button lock



DE-2865
18×9×2.2cm
7 Instruments Cassette Hinged
Lids, Click Lock, Available in 2
designs



DE-2866
21×14×3.5cm
15 Instruments cassette,
Detachable lids, button lock



DE-2867
21×14×3.5cm
15 Instruments cassette,
detachable lids, button
lock, with fitting of micro
surgery kit



DE-2868
21×14×4.5cm
8 pcs luxator/elevator
cassette, Detach0
ablelids, button lock



DE-2869
15×9×5cm
Box for dental implant tools and
surgical kits, Capacity:8
tools, 18 tools, 24 Tools, 58 Tools
+ removable compartment



Instruments Tray Perforated
DE-2870 288 x 187 x 40 mm



Instruments Tray Perforated Base
DE-2871 288 x 187 x 40 mm



Instruments Tray Solid Base
DE-2872 288 x 187 x 40 mm



DE-2873 Implant Basic Starter Kit 11 instruments with case



DE-2874 Crown Bridge Set Instruments with Case

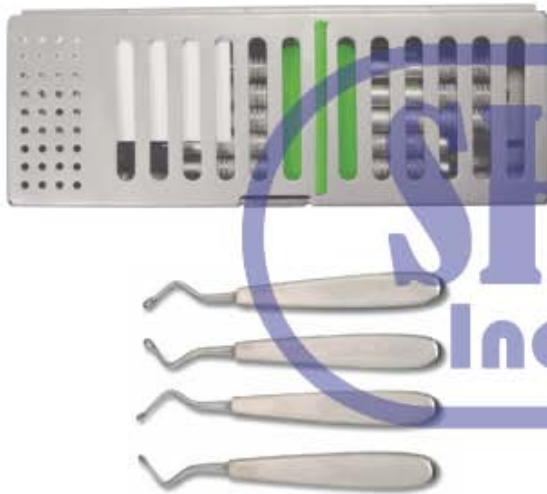

DE-2875 Bone Curettes Spoon Style set of 4 with Metal Case



DE-2876 Peritome Set of 2 with Blue Nitrate Tips and Metal Case

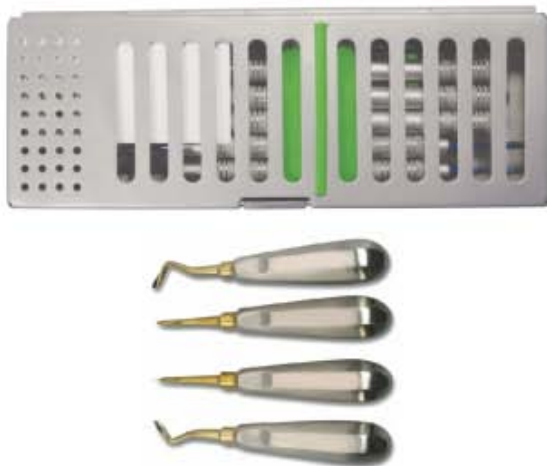

DE-2877 Root Fragment Removal elevators, Set of 4 with Metal Case



DE-2878 Peritome Set of 3 Gold Handles Serrated Blades with Metal Case

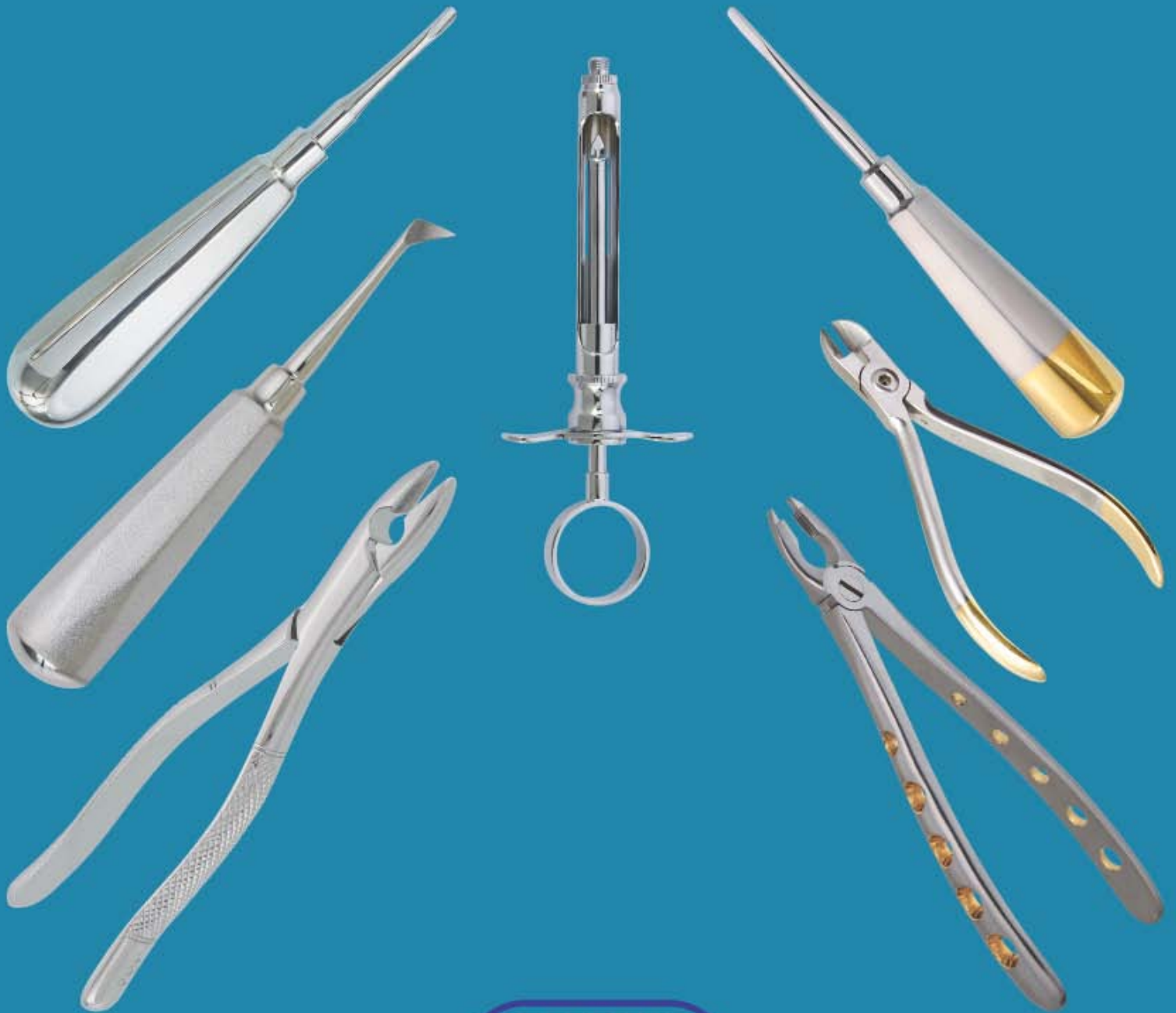

SHANI INDUSTRIES.

Manufacturers & Exporters of Surgical, Dental, Orthodontic,
Hollow Wears & Manicure Instruments.

Kashmir Road, Sialkot, Pakistan

Mobile Contact  :+92 333 8628101 +92 322 7346631

Tel Office: +92 52 4265646

E-mail: info@shaniindustries.com

URL: www.shaniindustries.com

